

# Vacuum Chucks for Wood Lathes

Bill Noble

March 2002

# Why?

- Hold stuff without marking it
- Quicker than a jam chuck (and no waste wood)
- It's another tool to play with
- Can hold irregular objects too

# How?

- Vacuum source (pump)
  - Positive displacement VS non positive displacement
    - Vacuum pump(more costly, more vacuum, less volume)
    - Shop Vac (cheap, low vacuum, more volume)
- Rotary Vacuum Fitting
- Miscellaneous plumbing
- Chucks to hold the work

# Positive Displacement Setup

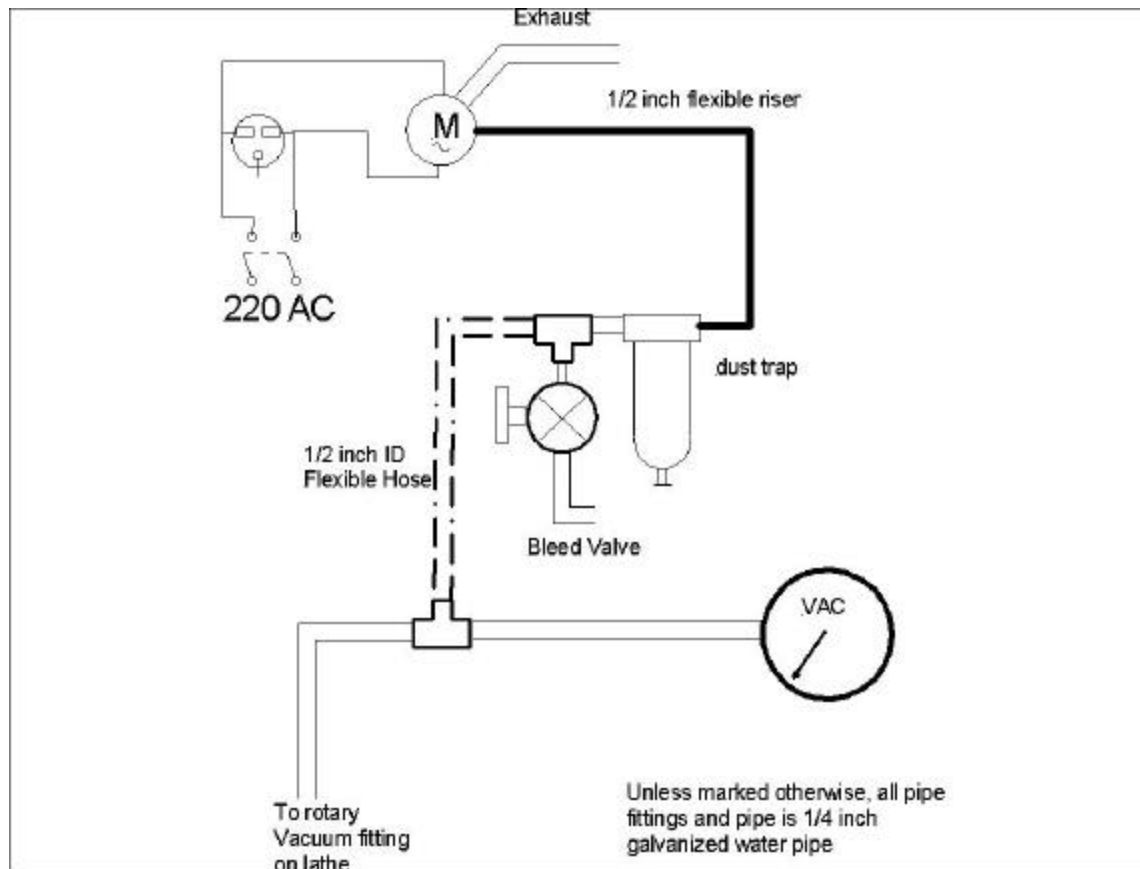

# Rotary Vacuum Fitting

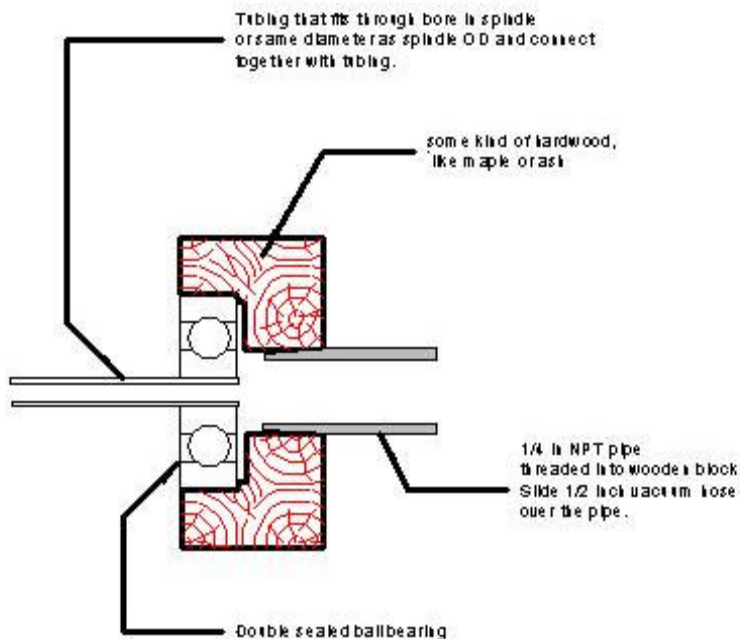

- Buy
  - See list of sources
- Make
  - Double sealed ball bearing
  - Tubing and wood

# Using a Shop Vac

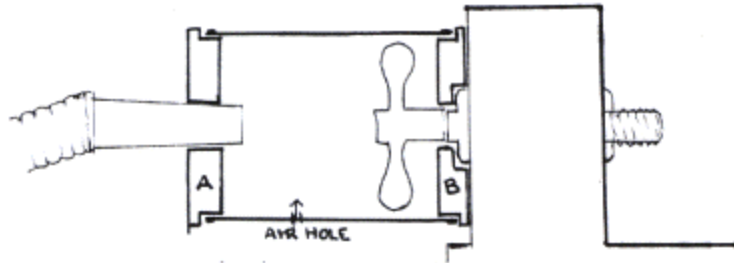

- Coffee can and wood to seal to headstock
- Shop Vacuum connected via hose
- Remove can when not using so you can reach the hand wheel

# Making a Chuck

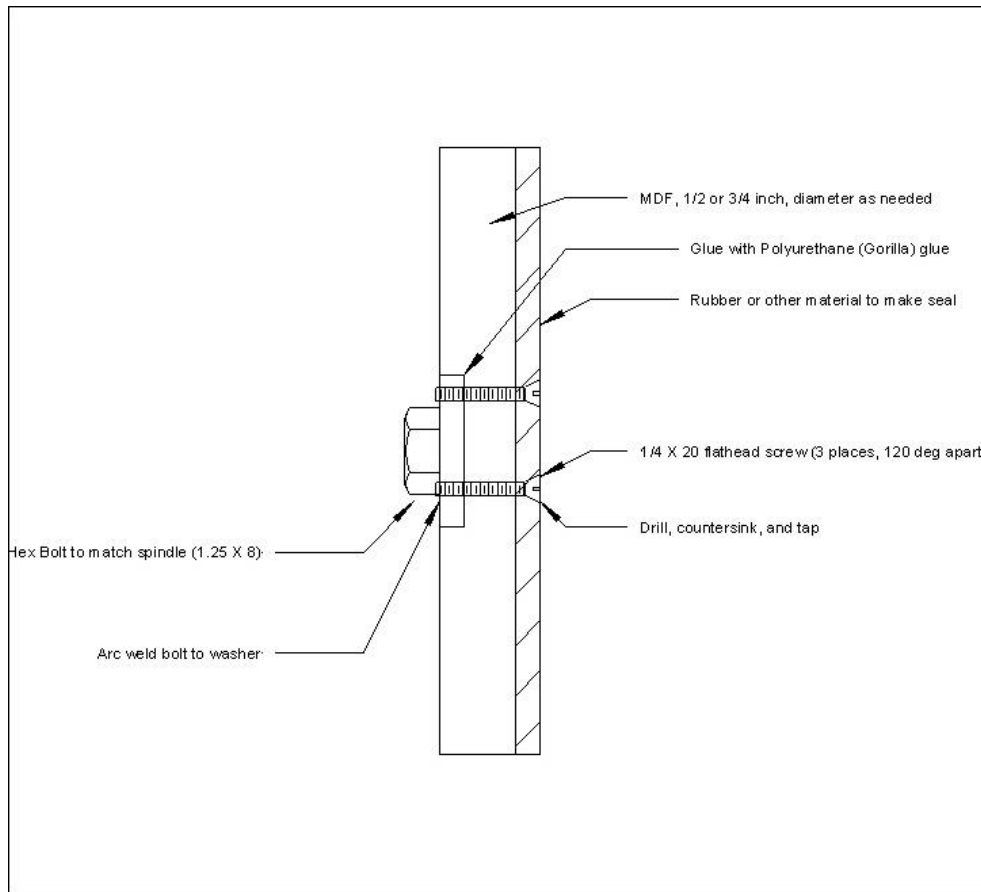

- MDF main body
- Nut/Washer for faceplate (weld)
- Rubber face for sealing to work

# Another Chuck

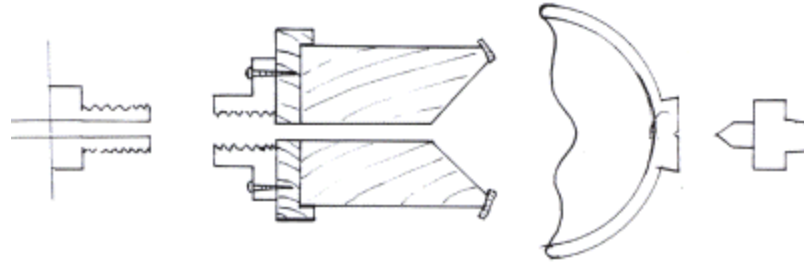

- Use MDF or hard wood
  - Paint to seal if it's porous
- Can use previous chuck with a groove and PVC pipe
  - Seal pipe to MDF with hot melt adhesive or urethane glue

# What do I make seals out of?

Material	Comment
Artificial chamois (for washing cars)	Good seal to a flat/round surface. Will provide a solid base for work
Closed cell foam (mouse pad, wet suit)	More conformal, will seal to more irregular or imperfect work. But because it is flexible, the work itself can move a bit, so you will have to use much lighter cuts
Neoprene rubber	Like the chamois, it is a rigid material that won't conform much to irregular surfaces
Other foam	Make sure the foam is closed cell. An open cell foam will allow air to pass and you will have a major vacuum leak.
Styrofoam	Haven't tried it, but it's pretty brittle.
Leather	See Chamois
Vinyl	Not a good choice, too rigid to seal to any but the most perfect surface.
Hot-Melt Glue	Soren Berger likes this seal

# Choosing a Pump

- Cost, Availability, Performance
  - Noise, ease of use
  - Rotary vane is best performance (CFM), but noisy

**Table 5 Pump Capacities and Applicable Vacuum Pumps**

Vacuum Pump Types	Maximum Vacuum Level (in. Hg)		Range of Capacities (CFM Free Air at 0 in. Hg.)	
	Continuous	Intermittent	Smallest	Largest
	Piston	27.5-28.5	-	1.3
Rocking Piston	25.5-29.0	-	1.22	2.7
Diaphragm	23.5-29.0	-	0.49	3.6
Rotary Vane (oil- lubricated)	10-28	25-28	1.3	55
Rotary Vane (Oil-less)	15-27	15-27	0.35	55

# Safety !!!

- Vacuum can cause significant pressure on the work – risk of implosion.
  - The larger the area evacuated, the greater the pressure

Diameter	Area (square inches)	Force on a bowl as a function of vac		
		5 in Hg	10 in Hg	20 in Hg
4 in	12.6	29	58	116
8 in	50.3	115.5	231	462
16 in	201.1	462	924	1848
32 in	804.2	1847	3694	7389

- Watch the walls
  - Do not use the “coffee can” approach with a positive displacement pump (may crush the can)
- Power failure or a catch can cause loss of vacuum
  - Take light cuts, protect yourself, keep RPM reasonable

# Sources

- Pumps and info
  - **Gast** Manufacturing Inc., a Div. of IDEX Corp.
    - P.O. Box 97  
Benton Harbor, MI 49023  
Tel: 616/926-6171  
Fax: 616/925-8288
    - Web: <http://www.gastmfg.com>
  - **Thomas** Industries Inc.  
1419 Illinois Avenue  
P.O. Box 29  
Sheboygan, WI 53082-0029  
Tel: 920-457-4891  
e-mail: [rtaylor@thomasind.com](mailto:rtaylor@thomasind.com)  
Web: <http://www.thomaspumps.com>
  - Surplus stores, Swap meets, etc
- Vacuum chuck kits and supplies
  - (Craft Supplies USA), 1-800-551-8876,  
[www.woodturnerscatalog.com](http://www.woodturnerscatalog.com) has a kit called the Artisan Vacuum Chuck System
  - E-Z Vacuum Adapter  
One-way Rotary joint  
<http://www.packardwoodworks.com/> 1-800 683-8876 Packard Woodworks, PO Box 718 Tryon, NC 28782
  - ***Venturi Based Vacuum System***  
<http://www.collectcraft.com/venturivacuum/>

# BASICS OF VACUUM CHUCKS / PUMPS

**Bill Hrnjak 1996**

The basic principle of vacuum chucking involves the science of the atmosphere around us. Normal atmospheric pressure, at sea level, is just under 15 pounds per square inch. That means if we create a vacuum, such as a vacuum chuck, the barrier between the atmosphere and the vacuum, in this case our turning, has a pressure exerted upon it by the atmosphere.

Vacuum is measured in inches of mercury or hg. A perfect vacuum is 30 inches of mercury (30 hg) and cannot be obtained on the surface of the earth. Most of the small pumps we use for our type of work are able to provide 22 to 28 hg, and this level of vacuum is more than sufficient for our purposes. In round numbers, the pressure exerted by the atmosphere is about one-half pound of force per square inch for every inch of mercury. This sounds confusing. Your system will have a gauge that reads from 0 to 30 hg. Divide the number on the gauge in half to find the pounds per square inch of force exerted on the turning. As an example, you have built a vacuum chuck that is 6 inches in diameter. You attach it to the lathe and apply vacuum and hold a turning. - The 6 inch diameter chuck has just over 28 sq. ins. of surface. If you run the vacuum up to 20 hg, the external pressure is about 10 PSI and the force exerted against the turning is a total of 280 pounds. 28hg increases the pressure to 392 pounds of force.

The pumps I use, and find very adequate, are surplus and of the dry rotary vane type. The impellers or vanes in the pump are made of graphite and require no lubrication. The size is 1/6 to 1/4 horsepower and they operate on 110 V power. These are extremely small for most commercial applications, but we are not evacuating large chambers and once we achieve vacuum, all we need to do is hold it. Larger pumps are noisier and use a lot more electricity to do the same work. The units I prefer have 1/4" pipe thread on the intake and the outlet of the pump and are small and easy to work with. A venturi vacuum valve is also available. This is a machined block of metal with threaded holes. You blow compressed air in one side, out the other side and a vacuum is created at the third opening. Simple? Cheap? Yes, but the amount of compressed air needed means your shop compressor will be running constantly to create and hold the vacuum. Not a very efficient use of electricity.

A quick comment on using a shop vac or household vacuum cleaner for this type of chucking. First, I have put a gauge on a lot of vacuum cleaners and, even with clean filters, I could only pull about 6 inches of mercury. Second, these types of motors rely on the air coming thru the hose to cool the motor. Blocking this flow to hold a vacuum for an extended period could cause the motor to overheat, the unit to quit, and your turning to become a flying object. Third, I cannot stand the noise a vacuum cleaner makes, especially for a prolonged period, when you need a peaceful environment to concentrate.

The pump is the basic part of any vacuum system. The fixture that allows use of vacuum on the lathe is a rotating fitting and shaft available from Packard Woodworks (catalogue page 11 / fall-winter 1996-97). The only thing you need to do is trim the threaded tube to length to fit your headstock. If you happen to cut this too short or change lathes, you will find this threaded tube in most hardware stores in the electrical or lighting supplies department.

The next element of this system is the chuck itself. This is something you make to fit your needs and the size and type of turning you do. I have made a half-dozen various chucks and plates to fit different lathes and to accommodate most shapes. This is a tool that you will use often. Buying a faceplate and permanently fixing it to your chuck will eliminate any kind of centering problems and make the process of using it simple and fun.

The next page shows details of a cup type chuck that I have built in several sizes. I have found that poplar is an excellent wood for the chuck body because it is non-porous. Alder allows a tremendous amount of air to be drawn through the wood and must be wrapped with tape to allow a vacuum to build. Painting the entire surface of the chuck increases efficiency by sealing pinhole leaks. The foam weather stripping used on the chuck is available everywhere. I have used black, gray and white. It must be marked "closed cell" on the package. "Closed cell" is available in both neoprene and plastic foam. I think the neoprene is a tougher, longer lasting product but it only comes in black. This can cause a problem. Black marks on any finish can be eliminated by using a sheet of clear plastic food wrap over the chuck with a hole punched in the face. Vacuum is the same and your turning will not pick up any dirt from the chuck itself. Wet suit rubber is another excellent choice, especially for a large flat disk.

The hardware and plumbing connecting the pump to the spindle is also quite simple if we break them into individual parts and explain their purpose. The filters on both the intake and the outlet are glass jars with a replaceable felt element inside. These protect the pump from dirt and your shop from graphite dust from the pump vanes. They also reduce the pump noise by about 95%. Without filters, the pump sounds like a siren or a huge router cutting aluminum. The filters have arrows cast into the top cap. These point in the direction of flow; into the intake port and out of the discharge port.

The next part of hardware is a vacuum gauge. This will tell you exactly how much force you are exerting on your work and verify that your system is holding vacuum. This gauge should be mounted between the intake filter and the end of the spindle. The exact location is not critical. Put it where you can see it clearly and where it will be safe.

from flying objects or other possible damage.

The next bit of plumbing is a valve. This should be a small needle or gate type valve as opposed to a ball valve. You want this valve to open very slowly and create a minor intentional leak in your system. This will allow you to set the system at a safe level of vacuum and hold it for as long as you wish. Again, this valve should be mounted between the intake filter and the headstock. The exact placement and method should be comfortable and handy for you and safe from accidental impact or unintentional adjustment.

The balance of the plumbing is the hose or tubing used to connect all the parts. I have had excellent results using 1/4" polypropylene tubing from home depot and brass compression fittings and brass crosses, tees, elbows, etc. I use pipe dope or Teflon tape on all the joints to eliminate any leaks and allow maximum vacuum in the system. On several chucks I have used silicone to seal the wooden cup or plate to the faceplate, added a rubber washer inside the faceplate to seal the end of the headstock shaft and applied rubber cement to increase the holding power of the self adhesive weather-stripping glue.

Plumbing completed, let's move on to electrical. Most of these pumps have no switch or at best a rocker switch on the cord. I have found it very convenient to install a toggle switch mounted in a handy box on the front of the lathe. The exact placement is up to you, but be careful that the placement does not allow you to accidentally bump or brush the switch and shut down the system. I have made most of these pumps permanent on one lathe. you may wish to make them portable or removable for use in other parts of the shop for vacuum bag clamps or vacuum hold downs on other tools.

In use, I usually attach the chuck to the spindle and hook the vacuum hose to the headstock. I turn on the pump and hold my finger over the hole in the bottom of the chuck. This closes the system and causes the gauge to read. I then use the valve to set the system to about 10hg on the gauge. This is very important when turning off bottoms on finished pieces. I have forgotten to check the setting and placed a thin piece on the chuck at full vacuum, 28 hg, only to suck the bowl inside out, right into the chuck, with a very loud bang, many flying fragments and a whole batch of new swear words.

The potential for using a vacuum is limited to your ideas and imagination. Build a basic system and don't be afraid to experiment. Turning off bowl bottoms is only one of many uses for this simple system.

I find most of my parts for these systems at C&H sales, a surplus store at 2176 East Colorado Blvd. in Pasadena. Inventory varies, but the prices are low and it is a gold mine for the tinkerer or inventor in all of us.

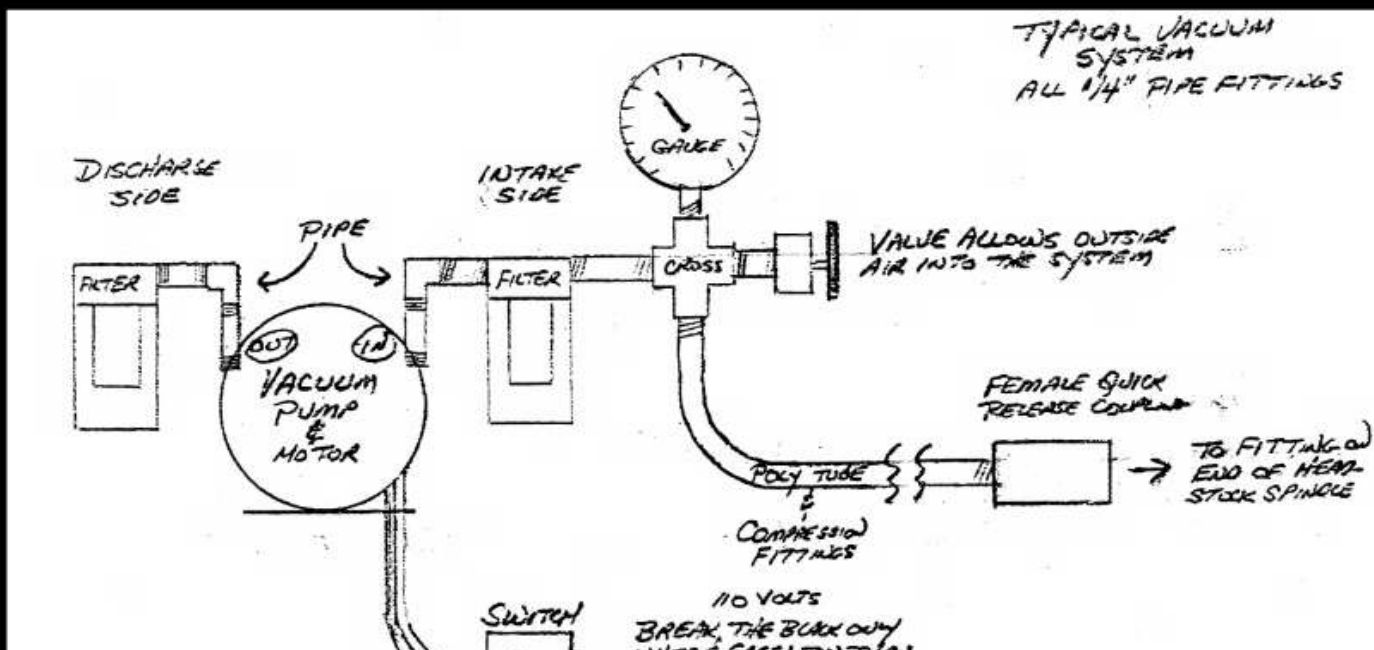



TYPICAL CUP CHUCK

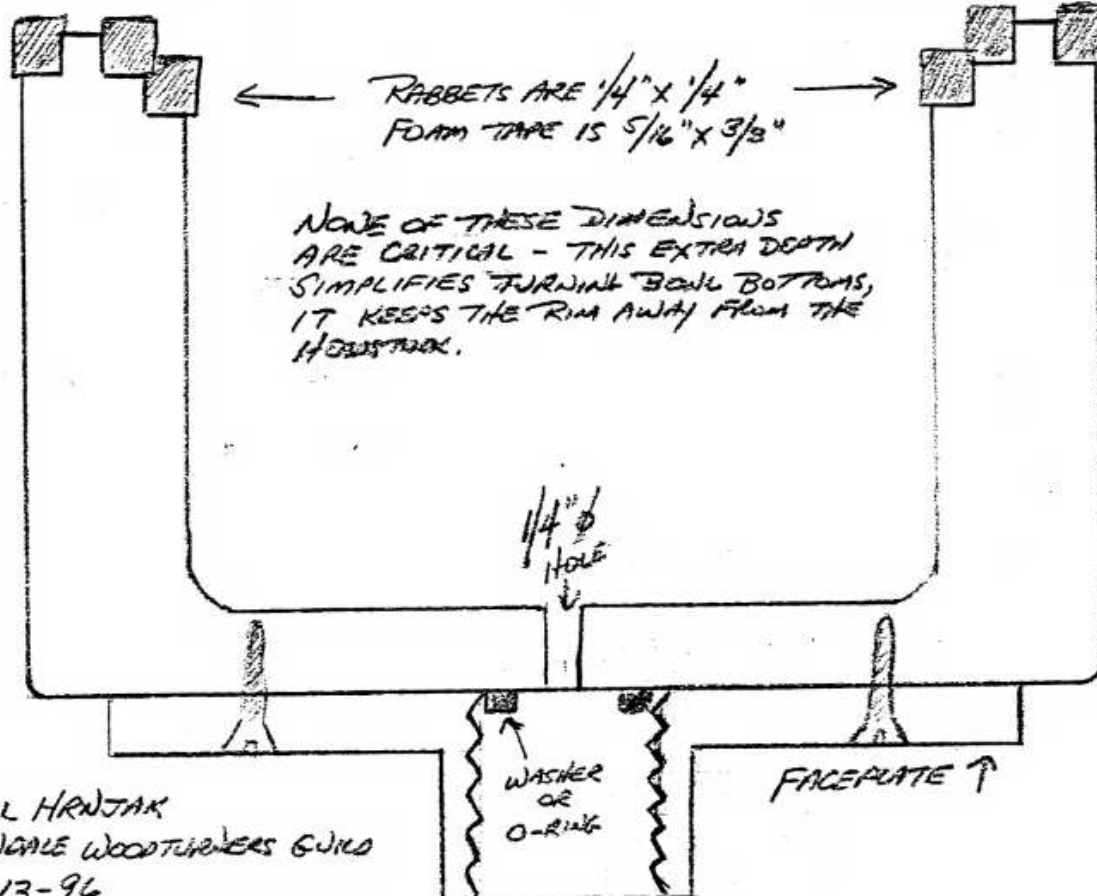

BILL HRNJAK  
GLENDALE WOODTURNERS GUILD  
12-13-96

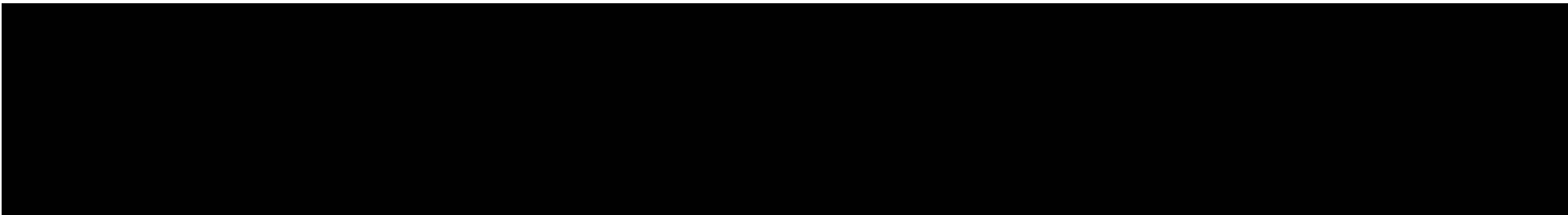

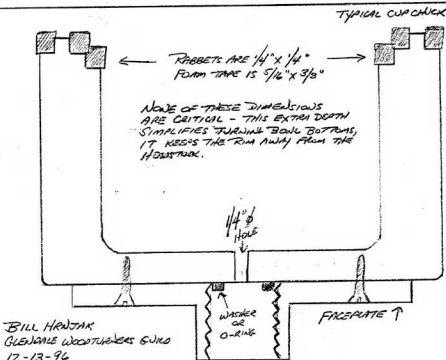
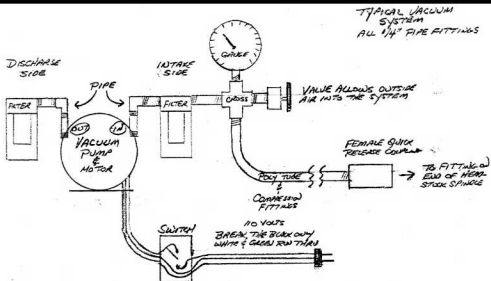

# Vacuum Chucks for Wood Lathes

Bill Noble

March 2002

# Why?

- Hold stuff without marking it
- Quicker than a jam chuck (and no waste wood)
- It's another tool to play with
- Can hold irregular objects too

# How?

- Vacuum source (pump)
  - Positive displacement VS non positive displacement
    - Vacuum pump(more costly, more vacuum, less volume)
    - Shop Vac (cheap, low vacuum, more volume)
- Rotary Vacuum Fitting
- Miscellaneous plumbing
- Chucks to hold the work

# Positive Displacement Setup

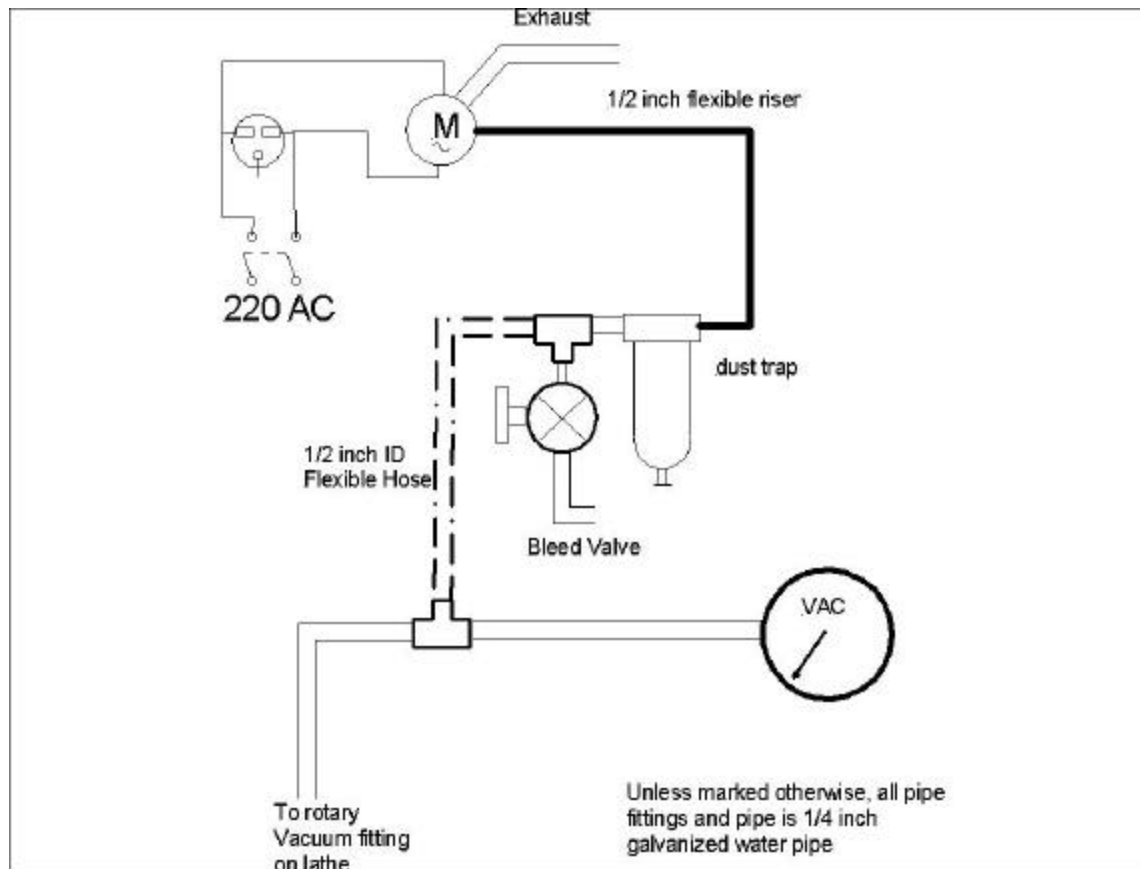

# Rotary Vacuum Fitting

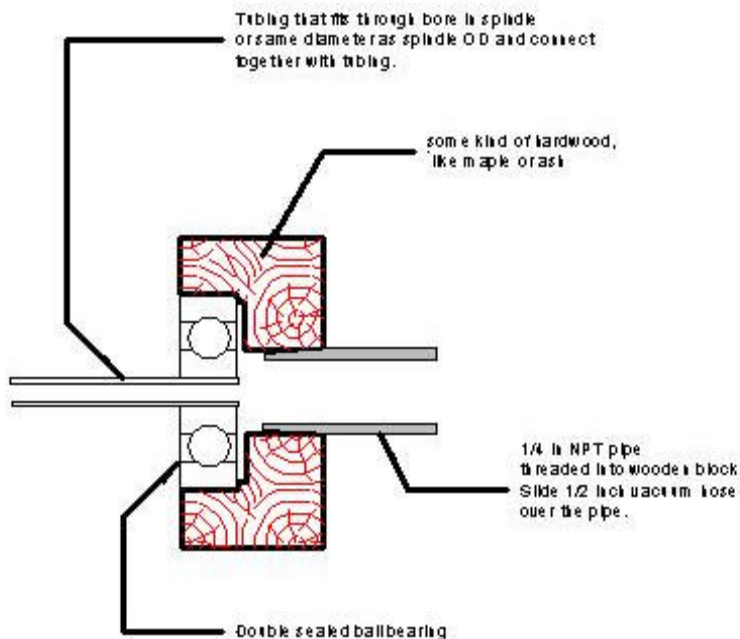

- Buy
  - See list of sources
- Make
  - Double sealed ball bearing
  - Tubing and wood

# Using a Shop Vac

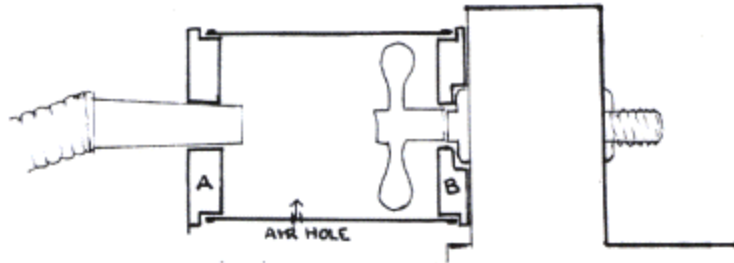

- Coffee can and wood to seal to headstock
- Shop Vacuum connected via hose
- Remove can when not using so you can reach the hand wheel

# Making a Chuck

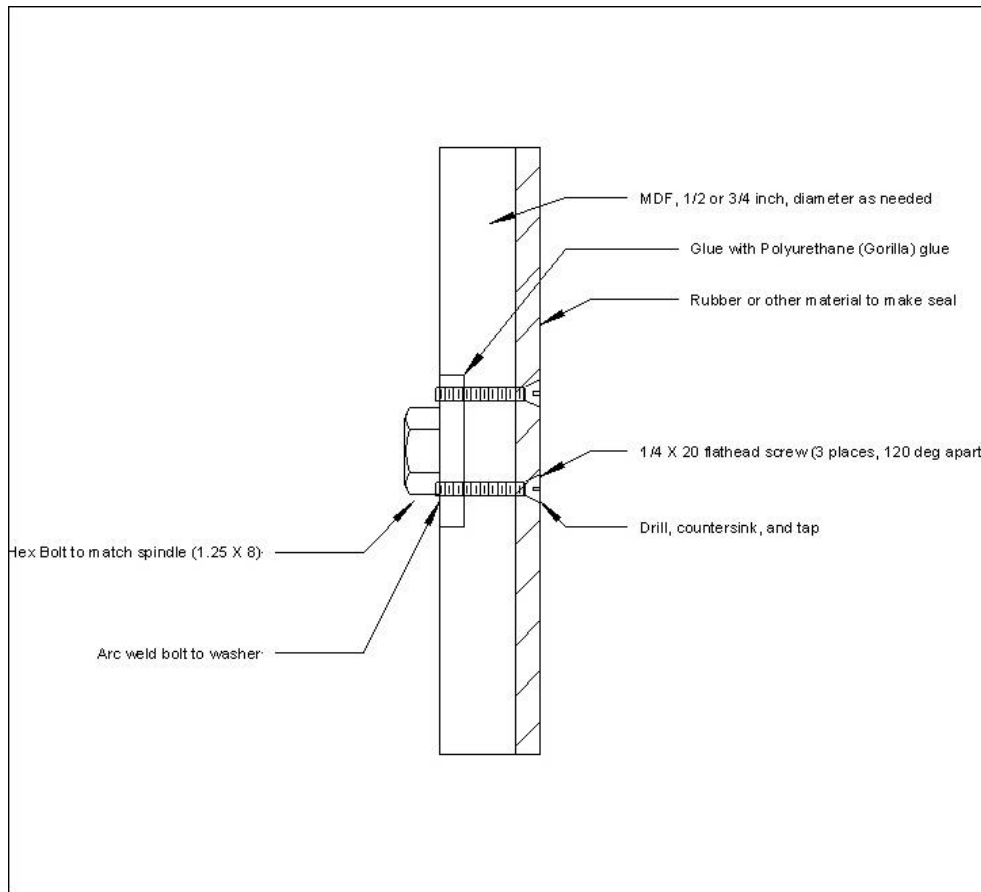

- MDF main body
- Nut/Washer for faceplate (weld)
- Rubber face for sealing to work

# Another Chuck

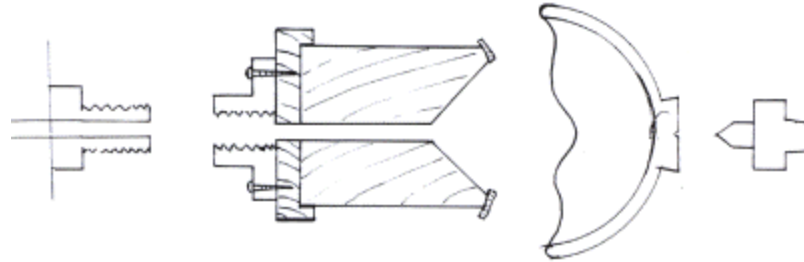

- Use MDF or hard wood
  - Paint to seal if it's porous
- Can use previous chuck with a groove and PVC pipe
  - Seal pipe to MDF with hot melt adhesive or urethane glue

# What do I make seals out of?

Material	Comment
Artificial chamois (for washing cars)	Good seal to a flat/round surface. Will provide a solid base for work
Closed cell foam (mouse pad, wet suit)	More conformal, will seal to more irregular or imperfect work. But because it is flexible, the work itself can move a bit, so you will have to use much lighter cuts
Neoprene rubber	Like the chamois, it is a rigid material that won't conform much to irregular surfaces
Other foam	Make sure the foam is closed cell. An open cell foam will allow air to pass and you will have a major vacuum leak.
Styrofoam	Haven't tried it, but it's pretty brittle.
Leather	See Chamois
Vinyl	Not a good choice, too rigid to seal to any but the most perfect surface.
Hot-Melt Glue	Soren Berger likes this seal

# Choosing a Pump

- Cost, Availability, Performance
  - Noise, ease of use
  - Rotary vane is best performance (CFM), but noisy

**Table 5 Pump Capacities and Applicable Vacuum Pumps**

Vacuum Pump Types	Maximum Vacuum Level (in. Hg)		Range of Capacities (CFM Free Air at 0 in. Hg.)	
	Continuous	Intermittent	Smallest	Largest
	Piston	27.5-28.5	-	1.3
Rocking Piston	25.5-29.0	-	1.22	2.7
Diaphragm	23.5-29.0	-	0.49	3.6
Rotary Vane (oil- lubricated)	10-28	25-28	1.3	55
Rotary Vane (Oil-less)	15-27	15-27	0.35	55

# Safety !!!

- Vacuum can cause significant pressure on the work – risk of implosion.
  - The larger the area evacuated, the greater the pressure

Diameter	Area (square inches)	Force on a bowl as a function of vac		
		5 in Hg	10 in Hg	20 in Hg
4 in	12.6	29	58	116
8 in	50.3	115.5	231	462
16 in	201.1	462	924	1848
32 in	804.2	1847	3694	7389

- Watch the walls
  - Do not use the “coffee can” approach with a positive displacement pump (may crush the can)
- Power failure or a catch can cause loss of vacuum
  - Take light cuts, protect yourself, keep RPM reasonable

# Sources

- Pumps and info

- **Gast** Manufacturing Inc., a Div. of IDEX Corp.
  - P.O. Box 97  
Benton Harbor, MI 49023  
Tel: 616/926-6171  
Fax: 616/925-8288
  - Web: <http://www.gastmfg.com>
- **Thomas** Industries Inc.  
1419 Illinois Avenue  
P.O. Box 29  
Sheboygan, WI 53082-0029  
Tel: 920-457-4891  
e-mail: [rtaylor@thomasind.com](mailto:rtaylor@thomasind.com)  
Web: <http://www.thomaspumps.com>
- Surplus stores, Swap meets, etc

- Vacuum chuck kits and supplies

- (Craft Supplies USA), 1-800-551-8876,  
[www.woodturnerscatalog.com](http://www.woodturnerscatalog.com) has a kit called the Artisan Vacuum Chuck System
- E-Z Vacuum Adapter  
One-way Rotary joint  
<http://www.packardwoodworks.com/> 1-800 683-8876 Packard Woodworks, PO Box 718 Tryon, NC 28782
- ***Venturi Based Vacuum System***  
<http://www.collectcraft.com/venturivacuum/>

# **Building a Vacuum Chuck System for Woodturning**

by

William Noble

March 2002

## Contents

Building a Vacuum Chuck System for Woodturning .....	1
1 Introduction.....	2
1.1 Why do you need a vacuum chuck .....	3
1.2 What are the alternatives to a vacuum chuck.....	3
1.3 What will it cost me? .....	4
2 How much vacuum is enough? .....	4
3 Types of Vacuum Sources .....	5
3.1 Venturis.....	5
3.2 Pumps.....	6
3.2.1 Vacuum Pumps: Basic Operation.....	7
3.2.2 Vacuum Stages.....	7
3.2.3 Oil-Less vs. Oil-Lubricated Vacuum Pumps .....	7
3.2.4 Positive Displacement Vacuum Pumps .....	8
3.2.5 Nonpositive Displacement Vacuum Pumps.....	9
3.3 Principles of Operation .....	9
3.3.1 Positive Displacement Pumps .....	9
3.3.1.1 Reciprocating Piston Pumps .....	9
3.3.1.2 Diaphragm Pumps .....	11
3.3.1.3 Rocking Piston Pumps .....	11
3.3.1.4 Rotary Vane Pumps.....	12
3.3.2 Nonpositive Displacement Pumps .....	14
3.3.3 Venturi Theory.....	15
3.4 Usage Considerations .....	16
3.4.1 Positive Displacement Pumps.....	16
3.4.1.1 Pump Recommendations .....	18
3.4.2 Nonpositive Displacement .....	18
4 How do you hook it up?.....	19
4.1 Setting Up a Positive Displacement Vacuum Pump .....	19
4.1.1 Muffler .....	20
4.1.2 Mounting the pump .....	20
4.1.3 Filter.....	21

4.1.4	Bleed Valve.....	21
4.1.5	Hose and Pipe.....	21
4.1.6	Gauge .....	22
4.2	A quick setup for a non-positive displacement pump.....	22
4.2.1	ADJUNCT TO VACUUM CHUCK .....	23
4.3	How to make your own rotary fitting .....	23
4.4	How to make the chucks .....	24
4.4.1	A flat chuck.....	24
4.4.1.1	A useful variation on the flat chuck .....	26
4.4.2	A raised chuck.....	26
4.5	Seals for the chucks.....	27
4.5.1	Soren Berger's note on seals.....	27
4.5.2	Other seal material .....	27
5	Additional information and sources .....	28
5.1	The VacuuMaster Chuck .....	28
5.2	Complete Vacuum Chuck kits and Rotary Fittings .....	29
5.2.1	The Woodturners Catalog.....	30
5.2.2	Oneway .....	30
5.2.3	E-Z Vacuum Adapter.....	30
5.2.4	Pisco Rotary Joints.....	31
5.3	Thomas pumps .....	31
5.4	GAST pumps.....	31
5.5	Building a Longworth Chuck.....	32
5.5.1	Introduction.....	32
5.5.2	Building Material.....	33
5.5.3	Construction.....	33

## 1 Introduction

This paper discusses the construction and theory of vacuum chucks for use on wood lathes. Vacuum chucks and vacuum holding devices are used in industry for a wide range of purposes, from lifting packages to holding items for machining. The discussion here is directed to the craft of woodturning and will generally avoid the other uses.

A vacuum chuck on a wood lathe is a device that can hold the work piece for final finishing. It is generally not suitable for holding something during initial shaping or hollowing.

### **1.1 Why do you need a vacuum chuck**

1. The short answer is that you don't really need one, but once set up it is a great convenience.
2. To finish off the bottom of an item, you can hold it with vacuum rather than a jam chuck or tailstock pressure. This helps you do better work.
3. For making multiple copies of an identical item, a vacuum chuck provides a quick, easy method of changing from one work piece to another.
4. It's easy, so it makes the work more fun – at least I don't like making jam chucks because I don't like throwing things away.

And anyway, it is really nice to be able to take just about anything and have it stick to your lathe while you turn it.

There are some limitations, however. If the item is very porous, air will pass through the walls of the item and it will not be held securely (or at all). If the item is very thin walled, the differential air pressure can crush it. And, it generally does not hold as securely as a scroll chuck or a faceplate.

### **1.2 What are the alternatives to a vacuum chuck**

If your goal is to be able to finish the foot of a bowl nicely, you have four alternatives.

1. Carefully part the bowl from the lathe and then finish the foot by hand or with power tools. This will work for any object, not just a bowl, but there are cases where it would be beneficial to be able to carve the inside of the foot on the lathe, which is largely impossible with this approach.
2. Reverse the bowl and hold it by its rim in a jam chuck. This of course, will not work for a natural edged bowl or any irregular object. It will allow you to work on the foot and turn its interior using the lathe.
3. Use a large scroll chuck to hold the bowl by the rim. As with the jam chuck, this will not work with an irregular object. The advantage over a jam chuck is that you don't have to keep making another one for each new piece you finish. An excellent design for a do-it-yourself chuck for this purpose is the Longworth chuck. <http://www.fholder.com/Woodturning/lwc-wtm.htm> contains construction plans for such a chuck, they are reproduced in section 5.5.
4. Hold the bowl (or object) in a vacuum chuck while you shape the bottom side of the foot.

The alternatives above are in order of increasing complexity and cost.

### 1.3 What will it cost me?

There is a list of commercial sources for the part you need at the end of this paper. The only expensive part is the vacuum pump. These can cost \$200 to \$400 new, but can frequently be found surplus or used for much less. Similarly, vacuum gauges can be found surplus for a few dollars, or bought new for \$15 to \$50. So, your expense will depend in large part to how much effort you are willing to spend to reduce expenses. A simple system build using your existing shop vacuum might cost almost nothing, whereas a system built using all new parts might cost around \$500. One of the goals of this paper is to give you enough information that you can make informed decisions about locating and selecting the parts for your vacuum chuck system.

## 2 How much vacuum is enough?

It depends on the size of the work. This may be counterintuitive, but larger work needs less vacuum. Why? Because it's air pressure that holds the work in place, and the air pressure is proportional to the area of the piece (technically, the contact area that is projected onto a plane perpendicular to the axis of rotation of the lathe). So, with the same vacuum, a 8 inch bowl will have 4 times the holding pressure as a 4 inch bowl, and 8 times the pressure of a 2 inch bowl.

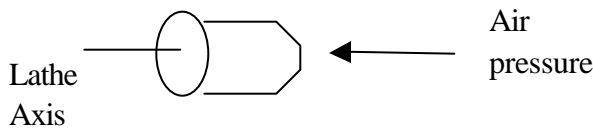

Air pressure is about 14.7<sup>1</sup> pounds per square inch at sea level, or 29.9 inches of mercury (or about 0.459375 PSI per inch of mercury). For historical reasons, vacuum is usually measured in inches of mercury, where 30 inches is considered a perfect vacuum. Of course for near perfect vacuums other units, such as the Torr are used, but we won't discuss them here.

Since air pressure varies with elevation, if you are in Denver, you will have less air pressure pushing your bowl against the vacuum chuck. Similarly, if there is a storm front coming and the barometer reads low, you will have less force. Remember, it isn't the vacuum that pulls the work, it's the outside air pressure that pushes it once you have removed the air inside the chuck so it can't push back.

Areas as a function of diameter is shown in Table 1, as you can see, there is a huge amount of pressure developed on a large bowl, enough to crush it if you are not careful. So, the high vacuum (if 20 inches is a high vacuum) is only needed with small objects. We won't delve here into cantilevered forces, but if you have a long thin object, it will move with sideways pressure despite the holding force below – this force is ONLY normal to the chuck (e.g. along the axis of rotation).

---

<sup>1</sup> STP, or Standard Temperature and Pressure is measured at 273.15K=0°C=32°F. IT is 1.01325 \* 10<sup>5</sup>

Pascals, or 1 atmosphere, or 14.7 pounds per square inch (PSI)

Diameter	Area (square inches)	Force on a bowl as a function of vacuum		
		5 in Hg	10 in Hg	20 in Hg
4 in	12.6	29	58	116
8 in	50.3	115.5	231	462
16 in	201.1	462	924	1848
32 in	804.2	1847	3694	7389

**Table 1 – The Force due to air pressure on a bowl held in a vacuum chuck**

There are a couple of considerations to keep in mind.

- First, the pump must have enough flow rate to actually produce the vacuum you need. This is why most systems include a vacuum gauge that is installed near the lathe so you can see what vacuum is actually being delivered to the chuck.
- Second, with a larger object the forces that can be produced are huge. It is certainly possible to crush the object with the force of the air. And if that happens there is a safety concern. If the lathe rotating when the object disintegrates, then pieces will be thrown from the lathe and can cause injury. Even if the lathe is not rotating, the force of the implosion can cause parts of the object to fly about at high speed. So, you need to be aware of the forces being developed. If you see the walls of your vessel start to deflect, reduce the vacuum.

### 3 Types of Vacuum Sources

#### 3.1 Venturis

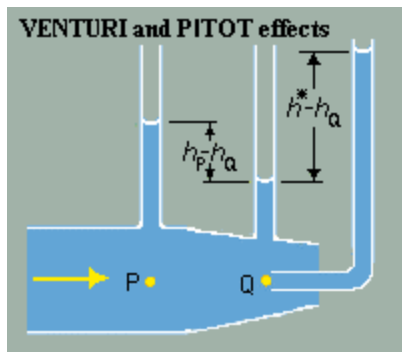

A venturi is a device that produces a vacuum from flowing air (or water). They are generally not suitable for our purposes, and are covered here for completeness.

As you can see from the table below, these devices use a goodly amount of shop air to produce the vacuum. They are also noisy (because of all the air flowing through them). Their value in some applications is that there are no moving parts, no electricity, and nothing to catch fire or burn. In other applications where there just happens to be plenty of moving fluid (for example, the carburetor of your car or the fill nozzle on a gas pump), they are used for convenience.

**INCHES OF MERCURY (H.G.)<sup>2</sup>**

MODEL NUMBER	INCHES OF MERCURY (H.G.) <sup>2</sup>						AIR CONSUMPTION AT 60 PSIG
	0	5	10	15	20	25	
10	.9	.7	.5	.2	.15	0	1.5
10L	1.4	1.1	.8	.3	0	0	1.5
33	1.5	1.2	.9	.6	.3	0	2.5
15	2.2	1.7	1.3	.8	.4	.1	3.5
15L	3.0	2.0	1.5	.9	0	0	3.5
20/22	4.0	3.2	2.4	1.6	.8	.2	6.4
20L/22L	5.5	4.4	3.0	1.7	0	0	6.4
2030	6.9	5.5	4.0	2.0	1.0	0	6.4
30/32	10	7.0	5.0	2.5	2.0	.3	8.6
30L/32L	12	9.0	7.0	3.0	0	0	8.6

### 3.2 Pumps

<sup>3</sup>Equipment used to generate vacuum is similar to air compressors. It's even possible to generate compressed air or vacuum with the same machine, depending on how it is installed. Vacuum pumps generally can be considered as compressors in which the discharge, rather than the intake, is at atmospheric pressure.

Recall that the essence of air compression is the increased number of molecular impacts per second. Conversely, the essence of vacuum generation is the reduction of these impacts. The vacuum in a chamber is created by physically removing air molecules and exhausting them from the system.

Removing air from the enclosed system progressively decreases air density within the confined space, thus causing the absolute pressure of the remaining gas to drop. A vacuum is created.

Because the absolute maximum pressure difference that can be produced is equal to atmospheric pressure (nominally 29.92 in. Hg at sea level), it is important to know this value at the work site.

For example, a pump with a maximum vacuum capability of 24 in. Hg cannot generate a 24-in. vacuum when the atmospheric pressure is 22 in. Hg (as in Mexico City, for instance). The proportion of the air evacuated will be the same, however. This pump therefore will pull  $22 \times 24 / 29.92$  or  $22 \times 24 / 30 = 17.6$  in. Hg vacuum in Mexico City.

<sup>2</sup> <http://www.vac-cube.com/pages/pg8.html>

<sup>3</sup> This overview of vacuum pumps is extracted from the GAST "Vacuum and Pressure Systems Handbook", available as a PDF file from <http://www.gastmfg.com/pdf/vacpresshdbk.pdf>

### 3.2.1 Vacuum Pumps: Basic Operation

A vacuum pump converts the mechanical input energy of a rotating shaft into pneumatic energy by evacuating the air contained within a system. The internal pressure level thus becomes lower than that of the outside atmosphere. The amount of energy produced depends on the volume evacuated and the pressure difference produced.

Mechanical vacuum pumps use the same pumping mechanism as air compressors, except that the unit is installed so that air is drawn from a closed volume and exhausted to the atmosphere. A major difference between a vacuum pump and other types of pumps is that the pressure driving the air into the pump is below atmospheric and becomes vanishingly small at higher vacuum levels. Other differences between air compressors and vacuum pumps are:

- The maximum pressure difference produced by pump action can never be higher than 29.92 in. Hg (14.7 psi), since this represents a perfect vacuum.
- The mass of air drawn into the pump on each suction stroke, and hence the absolute pressure change, decreases as the vacuum level increases.
- At high vacuum levels, there is significantly less air passing through the pump. Therefore, virtually all the heat generated by pump operation will have to be absorbed and dissipated by the pump structure itself.

### 3.2.2 Vacuum Stages

As in compression, the vacuum-generating process can be accomplished in just one pass through a pumping chamber. Or several stages may be required to obtain the desired vacuum. The mechanical arrangements are also similar to those for air compression. The discharge port of the first stage feeds the intake port of the second stage. This reduces the pressure, and hence the density, of air trapped in the clearance volume of the first stage. The net effect is, using a diaphragm pump as an example, that the second stage boosts the vacuum capability from 24 to 29 in. Hg.

### 3.2.3 Oil-Less vs. Oil-Lubricated Vacuum Pumps

As with compressors, the application normally dictates whether an oil-less or oil-lubricated vacuum pump should be used. Either type may be used in many applications.

**Oil-Less** - Oil-less pumps are almost essential when production processes cannot tolerate any oil vapor carry over into the exhaust air. They also can be justified on the basis of avoiding the cost and time of regularly refilling the oil reservoirs. This is particularly important when the pumps are to be mounted in inaccessible locations.

Modern piston pumps have rings of filled Teflon, which provide hundreds of hours of duty, depending on ambient temperature and air cleanliness. Diaphragm and rocking piston pumps are designed to be oil-less.

**Oil-Lubricated** - The oil-lubricated types have distinct advantages if proper maintenance is provided. They can usually provide about 20 percent higher vacuums because the lubricant acts as a sealant between moving parts. And they usually last about 50 percent longer than oil-less units in normal service because of their cooler operation. They also are less subject to corrosion from condensed water vapor.

### 3.2.4 Positive Displacement Vacuum Pumps

Vacuum pumps fall into the same categories as air compressors do. That is, they are either positive displacement or nonpositive displacement machines. A positive displacement pump draws a relatively constant volume of air despite variations in the vacuum levels.

As with air compressors, the principle types of positive displacement vacuum pumps are the piston, diaphragm, rocking piston, rotary vane, lobed rotor, and rotary screw designs. The remarks below cover aspects that apply to vacuum applications.

**Reciprocating Piston Pumps** -The primary advantage of the piston design is that it can generate relatively high vacuums from 27 to 28.5 in. Hg-and do so continuously under all kinds of operating conditions. The major disadvantages are somewhat limited capacities and high noise levels, accompanied by vibrations that may be transmitted to the base structure. In general, the reciprocating piston design is best suited to pulling relatively small volumes of air through a high vacuum range.

**Diaphragm Pumps** -The diaphragm unit creates vacuum by flexing of a diaphragm inside a closed chamber. Small diaphragm pumps are built in both one- and two-stage versions. The single stage design provides vacuums up to 24 in. Hg, while the two stage unit is rated for 29 in. Hg.

**Rocking Piston Pumps** -This design combines the light weight and compact size of the diaphragm unit with the vacuum capabilities of reciprocating piston units. Vacuums to 27.5 in. Hg are available with a single stage; two-stage units can provide vacuums to 29 in. Hg. Air flows, however, are limited, with the largest model available today (a twin-cylinder model) offering only 2.7 cfm.

**Rotary Vane Pumps** -Most rotary vane pumps have lower vacuum ratings than can be obtained with the piston design: only 20 to 28 in. Hg maximum. But there are exceptions.

Some two stage oil-lubricated designs have vacuum capabilities up to 29.5 in. Hg. (Also see the section on medium-vacuum pumps.) The rotary vane design offers significant advantages: compactness; larger flow capacities for a given size; lower cost (about 50 percent less for a given displacement and vacuum level); lower starting and running torques; and quiet, smooth, vibration free, continuous air evacuation without a receiver tank.

**Rotary Screw Pumps** - Vacuum capabilities of rotary screw pumps are similar to those of piston pumps, but evacuation is nearly pulse-free. Lobed rotor vacuum pumps, like the corresponding compressors, bridge the gap between positive and nonpositive displacement units. Air flow is high but vacuum capabilities are limited to about 15 in. Hg. Capabilities can be improved with staging.

### 3.2.5 Nonpositive Displacement Vacuum Pumps

Like the corresponding compressors, nonpositive displacement vacuum pumps use changes in kinetic energy to remove air from a system. The most significant advantage of this design is its ability to provide very-high-volume flow rates- much higher than possible with any of the positive displacement designs. But because of their inherent leakage, these machines are not practical for applications requiring higher vacuum levels and low flow rates.

The principle types of nonpositive displacement vacuum pumps are the centrifugal, axial-flow, and regenerative designs. Single-stage regenerative blowers can provide vacuums up to 7 in. Hg with flows to several hundred cfm. Vacuum capabilities of the other designs are lower unless they are multistaged.

## 3.3 Principles of Operation

This section briefly describes how the various types of pumps work. Note - these descriptions are drawn largely from the [GAST vacuum and pressure systems handbook](#). The descriptions below apply to compressors, but they illustrate the operation of the equivalent vacuum pumps. If you are not interested in how these devices work, feel free to skip this section.

### 3.3.1 Positive Displacement Pumps

#### 3.3.1.1 Reciprocating Piston Pumps

This design is widely used in commercial air compressors because of its high pressure capabilities, flexibility, and ability to rapidly dissipate heat of compression. And it is oil-less.

Compression is accomplished by the reciprocating movement of a piston within a cylinder. This motion alternately fills the cylinder and then compresses the air. A connecting rod transforms the rotary motion of the crankshaft into reciprocating piston motion in the cylinder. Depending on the application, the rotating crank (or eccentric) is driven at constant speed by a suitable prime mover. Separate inlet and discharge valves react to variations in pressure produced by the piston movement.

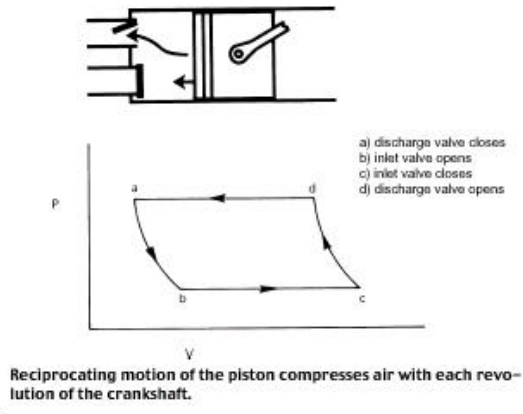

**Figure 1 – Reciprocating Piston Pump**

As the Figure 1 shows, the suction stroke begins with the piston at the valve side of the cylinder, in a position providing minimum (or clearance) volume. As the piston moves to a maximum volume position, outside air flows into the cylinder through the inlet valve. The discharge valve remains closed during this stroke.

During the compression stroke, the piston moves in the opposite direction, decreasing the volume of air as the piston returns to the minimum position.

During this action, the spring-loaded inlet and discharge valves are automatically activated by pressure differentials. That is, during the suction stroke, the piston motion reduces the pressure in the cylinder below atmospheric pressure. The inlet valve then opens against the pressures of its spring and allows air to flow into the cylinder.

When the piston begins its return (compression) stroke, the inlet valve spring closes the inlet valve because there is no pressure differential to hold the valve open. As pressure increases in the cylinder, the valve is held firmly in its seat.

The discharge valve functions similarly. When pressure in the cylinder becomes greater than the combined pressures of the valve spring and the delivery pipe, the valve opens and the compressed air flows into the system.

In short, the inlet valve is opened by reduced pressure, and the discharge valve is opened by increased pressure.

Some piston compressors are double-acting. As the piston travels in a given direction, air is compressed on one side while suction is produced on the other side. On the return stroke the same thing happens with the sides reversed. In a single-acting compressor, by contrast, only one side of the piston is active.

Single-acting compressors are generally considered light-duty machines, regardless of whether they operate continuously or intermittently. Larger double-acting compressors (usually watercooled) are considered heavy-duty machines capable of continuous operation.

Sizes of reciprocating piston compressors range from less than 1 hp to 6000 hp. Good part-load efficiency makes them very useful where wide variations in capacity are needed.

Their disadvantages? Reciprocating piston compressors inherently generate inertial forces that shake the machine. Thus, a rigid frame, fixed to a solid foundation, is often required. Also, these machines deliver a pulsating flow of air that may be objectionable under some conditions. Properly sized pulsation damping chambers or receiver tanks, however, will eliminate such problems.

In general, the reciprocating piston compressor is best suited to compression of relatively small volumes of air to high pressures.

### 3.3.1.2 Diaphragm Pumps

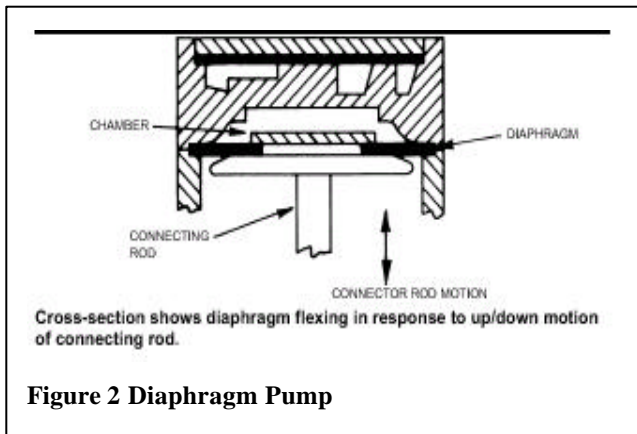

**Figure 2 Diaphragm Pump**

The diaphragm design is a modification of the reciprocating piston principle. An outstanding characteristic of the diaphragm design is that the basic compressing mechanism does not require a sliding seal between moving parts. A diaphragm compressor is also oil-less and it is therefore often selected when no oil contamination of the line or atmosphere can be tolerated.

Compression is performed by the flexing of a diaphragm back and forth in a closed chamber. Fig. 2 indicates how this flexing action is generated by the motion of a connecting rod under the diaphragm. Only a short stroke is required to produce pressure effects similar to those produced by a reciprocating piston in a cylinder.

Intake and discharge valves convert the volume changes produced by the reciprocating movement into pumping action. The reed-type valves work like those in the piston design.

### 3.3.1.3 Rocking Piston Pumps

The rocking piston principle (Fig.3) is another variation of reciprocal compression. In fact, it can be viewed as a combination of the diaphragm and piston principles. These pumps are called “Wob-L by Thomas, they are called Rock-R by GAST.

**Table 2 - Characteristics of Rocking Piston Pumps**

Performance	Features	Typical Applications	
<ul style="list-style-type: none"> <li>•Pressure to 175 psig (12 bar)</li> <li>•Vacuum to 29" Hg (31 mbar)</li> <li>•Air flow to 5.5 cfm (9,35 m<sup>3</sup>/h)</li> </ul>	<ul style="list-style-type: none"> <li>•Quiet</li> <li>•Oilless</li> <li>•Durable</li> <li>•Lightweight</li> <li>•Rugged Construction</li> <li>•Field Service Capability</li> <li>•Corrosion Resistant Models Available</li> </ul>	<ul style="list-style-type: none"> <li>•Oxygen Concentrators</li> <li>•Beverage Dispensing</li> <li>•Body Fluid Analysis</li> <li>•Automotive Suspension</li> <li>•Dental Vacuum Ovens</li> <li>•Vacuum Frames</li> <li>•Core Drilling</li> </ul>	 <p>Another reciprocating concept mounts a flexible cup at the top of the connecting rod and creates vacuum or pressure as the cup maintains a seal against the cylinder walls in a rocking motion.</p>



The rocking piston pump essentially mounts a piston rigidly (no wrist pin) on top of the diaphragm unit's eccentric connecting rod. This piston is surmounted by a cup made of Teflon, for instance. The cup functions both as a seal-equivalent to the rings of a piston compressor-and as a guide member for the rod. It expands as the piston travels upward,

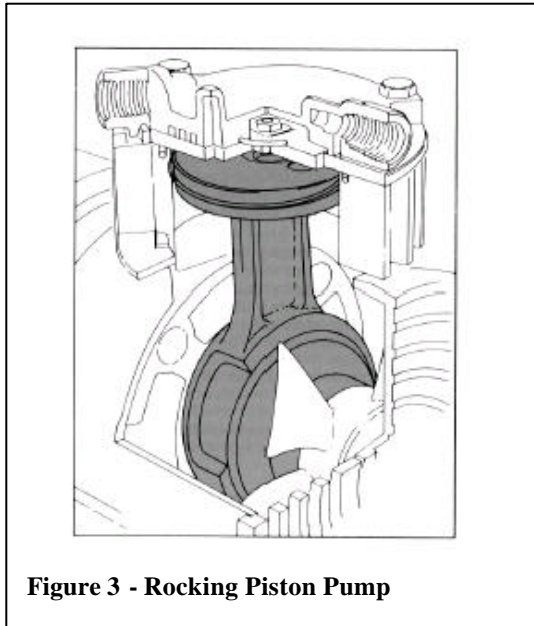

**Figure 3 - Rocking Piston Pump**

thus maintaining contact with the cylinder walls and compensating for the rocking motion.

The rocking piston compressor not only combines the mechanical features of the reciprocating piston and diaphragm types, but it also combines many of their best performance features. Like the diaphragm type, it is quiet, compact, and oil-less. Like the reciprocating piston unit, it can provide pressures to 100 psi.

The absence of a wrist pin is the key to the light weight and compact size of the rocking piston compressor. This makes the entire piston-connecting rod assembly much shorter and sharply reduces the overall dimensions and the weight of the unit.

**Table 3 TROUBLESHOOTING GUIDE for Rocking Piston Pumps**

Reason Possible	Pressure		Low vacuum	Excessive Noise	Overheating	Won't Start
	Low	High				
Dirty Filter	X					
Dirty Muffler			X			
Dirty Valves	X		X			
Bent/Damaged Valves	X		X			
Damaged/Worn Cup	X		X	X		
Leaky Hose	X		X	X		
Leaky Check Valve	X					X
Plugged Vacuum or Pressure Line		X	X		X	X
Low Voltage					X	X
Leaky Relief Valve	X					

### 3.3.1.4 Rotary Vane Pumps

Some applications require that there be little or no pulsation in the air output, and perhaps a minimum of vibration also. The rotary vane compressor (Fig. 17) provides this. It is commonly used for moderately high air flows at pressures under 30 psig, although some rotary vane designs can provide pressures of 200 psig. Rotary vane units generally have lower pressure ratings than piston units because of more difficult sealing problems and greater sensitivity to thermal effects.

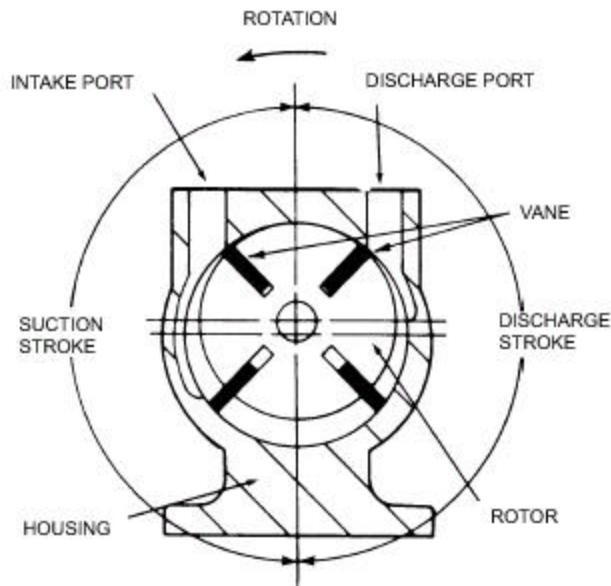

**In a rotary-vane compressor, the eccentrically mounted rotor creates smaller compression compartments as the vanes are pushed in by chamber walls.**

**Figure 4 - Rotary Vane Pump**

The Figure 4 above shows how pumping action is produced by a series of sliding, flat vanes as they rotate in a cylindrical case. As the rotor turns, the individual vanes slide in and out, trapping a quantity of air and moving it from the inlet side of the compressor to the outlet side.

There are no valves in the rotary vane design. The movement of the vanes controls the entire flow of air into and out of the individual compartments across separate inlet and discharge ports.

The rotor is mounted eccentrically -that is, not in the center of the casing. As the rotor rotates, the vanes are flung outwards and held against the body bore by centrifugal and pressure-loading forces. This creates a series of air compartments of unequal volume (because of the rotor's eccentricity). The compartments formed between adjacent vanes gradually become larger during the suction part of the cycle, and air is drawn into the compartment from the inlet port.

During the discharge portion of the cycle, the compartment volumes gradually become smaller, compressing the air. When a rotating compartment reaches the discharge port, the compressed air escapes to the delivery system.

The suction and exhaust flows are relatively free of pulsation because the inlet and discharge ports do not have valves, and the air is moved continuously rather than intermittently. Rotary vane compressors have certain significant advantages. In addition to providing smooth, pulse-free airflow without receiver tanks, they are compact (or, equivalently, offer high flow

### 3.3.2 Nonpositive Displacement Pumps

Also called "dynamic," "continuous-flow," and "velocity-type" compressors, this category comprises machines that use changes in kinetic energy to create pressure gradients. Kinetic energy is the energy that a body possesses by virtue of its motion. A fluid's kinetic energy can be increased either by rotating it at high speed or by providing an impulse in the direction of flow. The shop vacuum is a good example of this type of pump.

Unlike the positive displacement compressor, in which distinct volumes of air are isolated and compressed, a nonpositive displacement compressor does not provide a constant-volume flow rate over a range of discharge pressures. This is because the compartments are not isolated from each other and leakage between them increases as pressure rises.

Initial acceleration of the air produces a negative (suction) pressure at the inlet port, drawing air in. Partial deceleration of air at the discharge port converts some of the kinetic energy to pressure. Speed of the rotating impeller determines the pressure change. Higher pressure differences require either faster impeller speeds or additional stages.

The most important advantage of nonpositive displacement machines is their ability to provide very high mass flow rates. On the other hand, multiple stages are required to provide pressures above 4 or 5 psi and such machines are cost effective only for flow rates above 80-100 cfm. Nonpositive displacement devices are sometimes called fans or blowers rather than compressors. By some definitions, a fan provides less than 0.5 psi pressure and a blower between 0.5 and 10 psi. The distinction is frequently blurred in common use, however.

The three common types of nonpositive displacement compressors are centrifugal, axial, and peripheral (or regenerative). These names derive from the direction of air flow through their compression chambers.

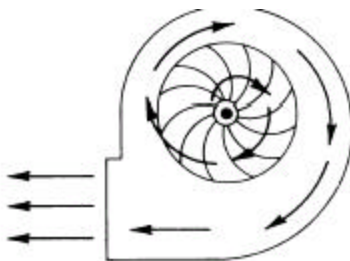

In a centrifugal blower, a rotating impeller sweeps air radially along the casing to the outlet.

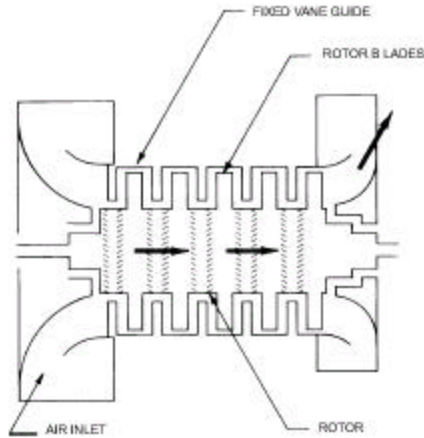

Air flows (arrows) through multistage axial flow blower. The fixed guide vanes between each stage keep air flow parallel to the axis of rotation.

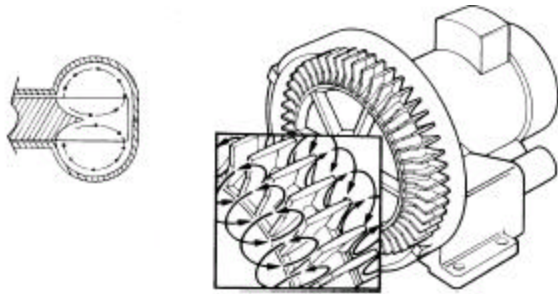

The arrows show the route air takes through a regenerative blower. Typical peripheral (regenerative) blower provides equivalent of multistage compression in a single revolution of the impeller.

### 3.3.3 Venturi Theory

You may feel free to skip this section unless you feel a desperate urge to mess with algebra and differential equations

Bernoulli's law indicates that, if an inviscid fluid is flowing along a pipe of varying cross section, then the pressure is lower at constrictions where the velocity is higher, and higher where the pipe opens out and the fluid stagnates. Many people find this situation paradoxical when they first encounter it (higher velocity, lower pressure). The well-known Bernoulli equation is derived under the following assumptions:

fluid is incompressible ( density  $\rho$  is constant );

flow is steady:  $\frac{\partial}{\partial t} = 0$

flow is frictionless ( $t = 0$ );

along a streamline;

Then, it is expressed with the following equation:

$$\frac{p}{\rho \cdot g} + \frac{v^2}{2 \cdot g} + z = h^* = \text{const.}$$

Where (in SI units):

$p$  = fluid static pressure at the cross section in  $N/m^2$ .

$\rho$  = density of the flowing fluid in  $kg/m^3$

$g$  = acceleration due to gravity in  $m/s^2$  (its value is  $9.81 m/s^2 = 9810 mm/s^2$ )

$v$  = mean velocity of fluid flow at the cross section in  $m/s$

$z$  = elevation head of the center of the cross section with respect to a datum  $z=0$

$h^*$  = total (stagnation) head in  $m$

The terms on the left-hand-side of the above equation represent the pressure head ( $h$ ), velocity head ( $h_v$ ), and elevation head ( $z$ ), respectively. The sum of these terms is known as the total head ( $h^*$ ). According to the Bernoulli's theorem of fluid flow through a pipe, the total head  $h^*$  at any cross section is constant (based on the assumptions given above). In a real flow due to friction and other imperfections, as well as measurement uncertainties, the results will deviate from the theoretical ones.

In our experimental setup, the centerline of all the cross sections we are considering lie on the same horizontal plane (which we may choose as the datum,  $z=0$ ), and thus, all the 'z' values are zeros so that the above equation reduces to:

$$\frac{p}{\rho \cdot g} + \frac{v^2}{2 \cdot g} = h^* = \text{const.} \quad (\text{This is the total head at a cross section}).$$

### 3.4 Usage Considerations

This section provides an overview of the key considerations in choosing one type of pump over another.

#### 3.4.1 Positive Displacement Pumps

The tables below are a good guide to the range of pumps and their selection factors. These tables are from the [GAST vacuum and pressure systems handbook](#). They are typical of what is found in pumps by other manufacturers also.

A good assumption for our vacuum chuck application is that you would like 20 inches to 25 inches of vacuum available at the pump.

**Table 4 Vacuum Ratings and Applicable Vacuum Pumps**

<b>Max. Vacuum Rating (In. Hg)</b>	<b>Types of Vacuum Pumps</b>
<b>Continuous</b>	
27.5 to 28.5	Piston (multistage)

25.5 to 29	Rocking piston
24 to 29	Diaphragm (single & multistage)
10 to 28	Rotary vane (oil-lubricated)
15 to 26	Rotary vane (oil-less)
7	Regenerative peripheral blower

**Table 5 Pump Capacities and Applicable Vacuum Pumps**

Vacuum Pump Types	Maximum Vacuum Level (in. Hg)		Range of Capacities (CFM Free Air at 0 in. Hg.)	
	Continuous	Intermittent	Smallest	Largest
Piston	27.5-28.5	-	1.3	10.5
Rocking Piston	25.5-29.0	-	1.22	2.7
Diaphragm	23.5-29.0	-	0.49	3.6
Rotary Vane (oil-lubricated)	10-28	25-28	1.3	55
Rotary Vane (Oil-less)	15-27	15-27	0.35	55

**Table 6 Availability of Motor-Mounted Vacuum Pumps**

Vacuum Pump Type	Range of Open Capacities (cfm)	Motor H.P. Requirements
Piston (1-stage)	1.8 to 10.5 cfm	1/6 to 3/4
(2-stage)	1.15 and 2.30 cfm	1/8 and 1/4
Rocking piston (1-stage)	1.12 to 1.6 cfm	1/8 to 1/4
(2-stage)	1.25 to 2.7 cfm	1/4
Rotary vane (oil-lubricated & oil-less)	0.60 to 10.0 cfm	1/15 to 3/4

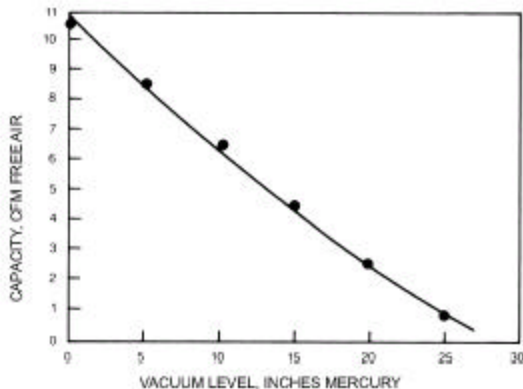

**Figure 5 Capacity versus vacuum level for a single stage reciprocating piston pump.**

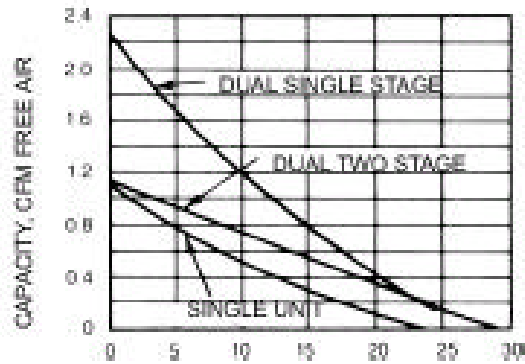

Figure 6 Capacity vs. vacuum level for different types of diaphragm vacuum pumps: single cylinder, twin cylinders in parallel (dual single-stage), and twin cylinders in series (dual two-stage).

#### 3.4.1.1 Pump Recommendations

Some recommendations and considerations for choosing a pump for wood turning are:

1. The rotary vane type pumps will produce more noise than the others
2. 1/8 to 1/3 HP rotary vane pumps can be used successfully. If cost and weight are not a factor, use the larger horsepower to have more margin to handle porous wood and leaks in the system.
3. 1/3 HP rocking piston pumps can be used successfully. These are quieter than the vane pumps.
4. An oil-less design should be chosen to ensure that oil in the exhaust air does not contaminate your work, and to eliminate the need for periodic lubrication
5. A rotary vane pump can also be used as an air compressor to blow dust off the work. A piston pump used in the same manner will stall if a relief valve is not provided. This is not a consideration if the only use is as a vacuum source.
6. Choose a convenient pump primary voltage – in the USA 110/120VAC is most common. If your lathe operates on 220VAC, then that is a viable option also.
- 7.

#### 3.4.2 Nonpositive Displacement

A Shop Vacuum is a nonpositive displacement pump, and it's a common tool in almost any wood shop.

Any good shop vacuum will draw an inch or two of vacuum. The drawbacks of this type of system are:

1. Noisy
2. Can't hold small objects because it may not provide sufficient vacuum.
3. Must ensure a flow of air to the motor (e.g. lots of leakage) to avoid overheating it i.e., in this type of vacuum pump, the air that the vacuum pump draws is the same air as is used to cool the motor. If the air is restricted, such as it would be in the situation of a vacuum chuck, the motor does not get sufficient cooling.
4. Your shop vacuum will wear out faster

The advantages are:

1. Almost free (everyone has a shop vacuum)
2. Can tolerate a system with quite a lot of leakage
3. Dust and shavings are no problem
4. Minimal special equipment

## **4 How do you hook it up?**

The key parts of a positive displacement vacuum hookup are:

1. The pump
2. A filter to keep dust and shavings out of the pump
3. A bleed valve to control vacuum
4. A vacuum gauge (optional) so you know what's happening
5. A rotary vacuum fitting on your lathe
6. The chuck itself

Non-positive displacement systems can be connected as shown in 4.2.

### **4.1 Setting Up a Positive Displacement Vacuum Pump**

Figure 7 shows a typical setup for a positive displacement pump. In this case, the lathe has a built in vacuum port, and the pump is 220 VAC. Section 4.3 shows how to make a rotary fitting if your lathe is not equipped with a built in vacuum port. The choice of 220VAC for the pump versus 110AC is a matter of convenience. If you can get a better price on a 220VAC pump and you have 220VAC handy, then by all means use it. If you don't have 220VAC, then of course you will want to limit yourself to 110VAC pumps.

When you wire the electrical portion of the setup, you will wish to decide where to place the switch. There are two basic strategies:

1. Place the switch physically near the pump, typically on the pump body itself, or
2. Place the switch at some distance from the pump.

If you will use the pump with several lathes, or for other purposes, then you will want to mount the switch on the pump. On the other hand, if this is a permanent installation, the pump is best placed in an out of the way location, and so you should mount the switch where you can reach it easily. If you are adding wiring (for example the 220VAC plug in the diagram), then it may be expedient to include a wall-mounted switch. If you mount the pump where you cannot hear if it is running or not, then include an indicator with the switch to remind you that the pump is on.

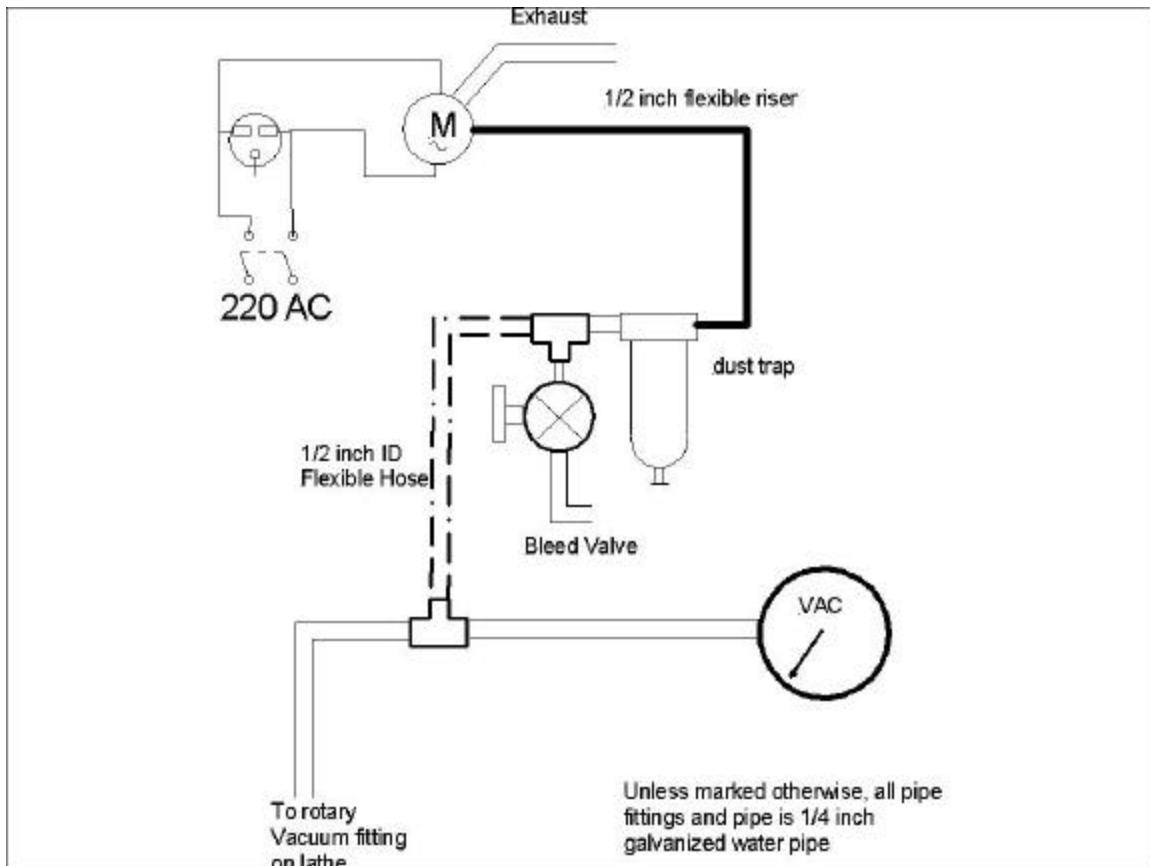

Figure 7 - A typical setup for a positive displacement vacuum pump

#### 4.1.1 Muffler

In the diagram above, the exhaust from the pump is shown going into a pipe. Depending on the type of pump, you may well wish to make some kind of muffler to quiet the sound of the pump. This is particularly true for vane type pumps, which if unmuffled sound rather like a siren at close range. I used a dual wobble piston pump, so there was significant pulsation in the output air. To make a muffler, I attached about 6 feet of scrap medical air hose – the clear flexible hose that is used with oxygen apparatus. I just coiled this hose up after connecting it to the output port. The hose I used was  $\frac{3}{4}$  ID and slipped nicely over a  $\frac{1}{4}$  to  $\frac{3}{8}$  inch adapter. The particular hose has accordion style ripples in it which break up the sound waves, so that over the 6 foot length the pulsations are pretty much damped out. I then took the output of the hose and directed it at the pump motor to provide additional cooling.

If you have a vane type pump, they usually come with an input and output filter/muffler. If you lack one, a baby food jar with some cotton wool in it will do nicely.

#### 4.1.2 Mounting the pump

All pumps vibrate, some more than others. Vane pumps vibrate the least. I initially hard mounted the pump to the ceiling plate of my workshop. This got the pump out of the way so I didn't have to worry about tripping over it, and it protected my fingers from the pump's fan blades. But, by hard mounting it, I ended up coupling all of the vibration from the pump into the wall, which acted as an amplifier. To quiet it down a bit, I added some rubber between the pump and the mounts – a few scraps of an old tire will do fine, as will pieces of a mouse pad or anything else convenient. I would not use Styrofoam because it doesn't hold up very well over time.

### 4.1.3 Filter

A filter or a series of filters is needed to keep dust out of the pump. A commercial air line filter will work well. You can make your own filter by using some large diameter galvanized pipe (for example, 2 inch) filled with cotton wool or wadded up filter medium or even a rag. Put a cap on each end and drill and tap the cap for ¼ inch pipe (or use a reducing fitting). Filters with a clear jar allow you to see what's piling up in the filter and know when to change it. If you were using a vane pump with its own filter, I'd still add another in-line filter just to be safe. The carbon blades on a vane pump are too expensive to have to replace them due to sawdust damage.

### 4.1.4 Bleed Valve

As illustrated in Table 1 at the beginning of this paper, even a modest vacuum applied to a large surface area can produce forces on the work piece. Therefore you need some way of ensuring that you don't crush the work piece. You do this with a bleed valve, which basically lets you leak air into the system in a controlled manner. You can use pretty much any valve, although I would recommend against a gate valve because they typically do not seal well. You want the valve to seal well for those times when you really do need maximum vacuum.

There are ball valves (used for gas shutoff type applications), but they are too hard to adjust for small flow rates. So the best choice is a small (for example ¼ inch) water valve that takes several turns on the handle to go from fully closed to fully open.

### 4.1.5 Hose and Pipe

Unless you have a lathe with a built in vacuum fitting AND you mount the entire mechanism to the lathe, you will want to use flexible hose to connect the portion of the system on the lathe to the portion not on the lathe. This is shown as the ½ inch flexible hose in the diagram above. I also found it expedient to not have to cut and thread a lot of pipe, so I used ½ inch flexible sprinkler pipe (called "flexible riser") to connect from the dust trap to the vacuum motor. Conveniently, the OD of ¼ inch galvanized pipe is just about ½ inch, so you don't need fancy fittings to go from the threaded fittings (which for the pumps and whatnot that we are talking about are usually ¼ inch) to the flexible hoses, just use short lengths of ¼ inch galvanized pipe.

A hose clamp at each end of each hose will minimize vacuum leaks.

### 4.1.6 Gauge

A vacuum gauge is handy so you can see what's happening, but it probably isn't essential. And, accuracy is not important, so pretty much any old gauge will do. If you are assembling a system and don't have a gauge handy (yet), then leave a place for it (as shown in the figure) and just close it off with a pipe cap or plug until you are ready to affix a gauge. If you don't do this, you may find that you have to undo a whole bunch of fittings when you decide to add a gauge later.

You can usually find gauges at surplus stores and swap meets – they are often found around car parts swap meets because they are used (or were used) to diagnose engine problems. If you find a gauge with a broken lens (glass), don't despair; you can make a new one out of plastic on the lathe. If the gauge is missing the bezel that holds it in place, use tape or silicon glue to affix a new lens. You do want to cover the gauge though rather than have no lens because otherwise it will collect dust inside and quit working.

## 4.2 A quick setup for a non-positive displacement pump

This method is courtesy of the Peninsula Woodturners Guild (K. MacLeod.) <http://home.vicnet.net.au/~pwguild/vacuum.htm> with a few additions by the author.

The discussion in this section sets forth a quick and easy way to make a shop vacuum based system.

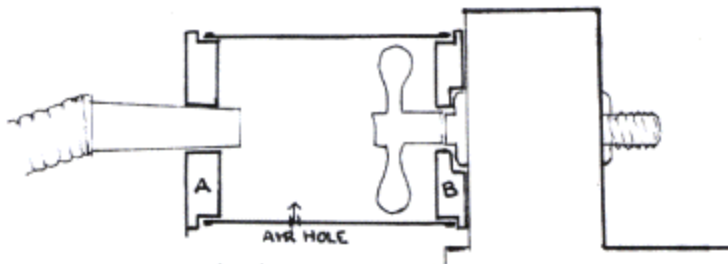

Figure 8 Simple Vacuum Connection

- 1.. Find a can with diameter just larger than that of hand wheel such as an olive oil can (a length of suitable diameter PVC pipe will also work).
2. Cut out both ends.
3. Turn A from craft board to fit snugly into can. Turn hole to fit vac. hose end. Fix can to A with nails or screws or glue or contact cement.
4. Turn B. to push fit into can. Turn hole to fit over shaft or bearing housing or whatever.
5. Fix B permanently to lathe head. Drill and tap holes for small metal thread screws, or use contact cement, or epoxy putty.

### COMMENTS

Drill a hole (say 4 mm.) somewhere along the vacuum. line to allow some airflow to cool the motor otherwise you might cook it.

If your hand wheel must be removed for any reason you can use a smaller can, but you then have the bother of removing the hand wheel each time, and you lose the advantage of the quick fit.

A slight concavity in the face of the suction pad allows for a more positive grip on flatter objects like coasters or platters.

Remember strength of suction depends on area of job (Lbs / sq. inch) so larger jobs grip very firmly. Be wary of the small diameter. jobs.

#### 4.2.1 ADJUNCT TO VACUUM CHUCK

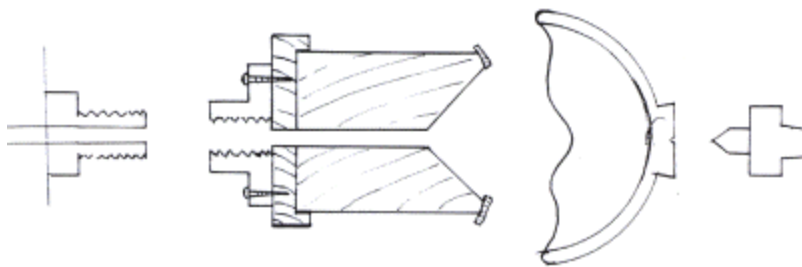

Figure 9 - A simple Vacuum Chuck

If you want to modify the foot of a natural edged bowl using a vacuum chuck try something like this.

Basically it is a large wooden tube with the rim curved to nearly match that of the inside of a bowl, and with the rim edge covered with the usual sponge rubber material to make a good suction seal. (See 4.5 for another suggestion, and note that a non-porous wood should be used, for example maple or even MDF, not oak. A couple of coats of lacquer or paint will help seal the wood so it doesn't leak)

It is necessary to leave some means of centering the bowl onto the vacuum chuck adaptor using the tail stock until the vacuum takes over, then remove tail stock and finish foot of bowl to your design.

Remember small diameter vacuum chucks do not grip as positively as larger ones.

#### 4.3 How to make your own rotary fitting

You can buy a commercially made rotary fitting to connect the vacuum to your lathe's spindle (see section 5), or you can buy a lathe like the Stubby that has a vacuum port built in, or you can make your own rotary fitting.

Figure 10 shows how to make such a fitting. You need some tubing that will seal to the spindle, a double sealed ball bearing, a block of wood, and a short piece of ¼ inch NPT pipe.

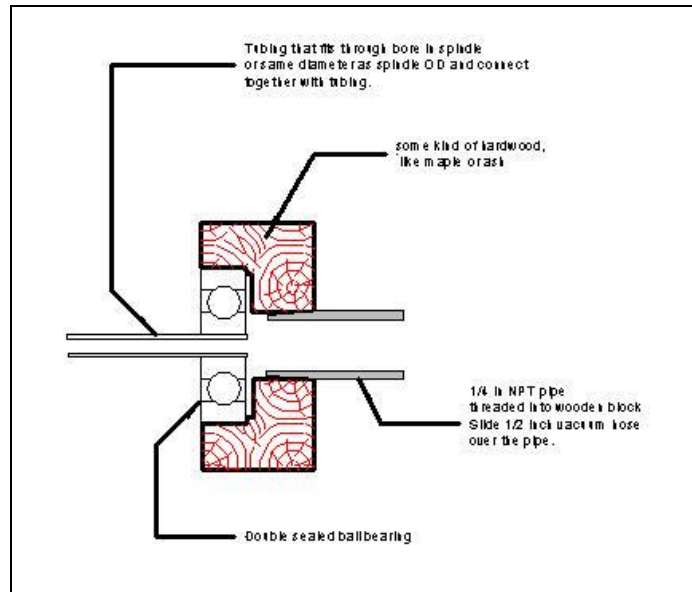

**Figure 10 - Make Your Own Rotary Vacuum Connection**

The bearing ID should match the tubing you have chosen to mate with the spindle. The bearing OD is not critical. Turn a recess in the wooden block to hold the bearing, and leave a small “shelf” that extends about 1/8 of an inch into the recess, as shown in the figure. This gives the bearing outer race something to sit against without any risk of the inner race rubbing on the wood.

Then, drill and tap a hole for the 1/4 NPT pipe in the center of the block, and thread the pipe into the block. Use RTV or polyurethane glue to seal the bearing outer race to the block. Provide some way to ensure that the block does not rotate, and you are done.

Note that it’s perfectly OK to reverse the above assembly and have the block rotate with the hand wheel if this is more convenient.

On the commercial units, the small tube slides through the hole in the spindle and is then sealed to the working end of the spindle with a special fitting. There are a number of ways of duplicating this, including having the small tube screw into the vacuum chuck itself, using RTV silicone adhesive to seal the small tube to the inside of the spindle, and using an O-ring and screws to clamp and seal the assembly to the hand wheel (this of course reverses the above assembly).

If you want a more rugged unit, two ball bearings spaced half an inch apart will add significantly to the ability of the unit to withstand lateral forces, such as caused by the weight of the vacuum hose.

If you do not have a hole through the center of your spindle, there is an adapter (see section 5.1) that will allow you to deal with this situation.

## **4.4 How to make the chucks**

### **4.4.1 A flat chuck**

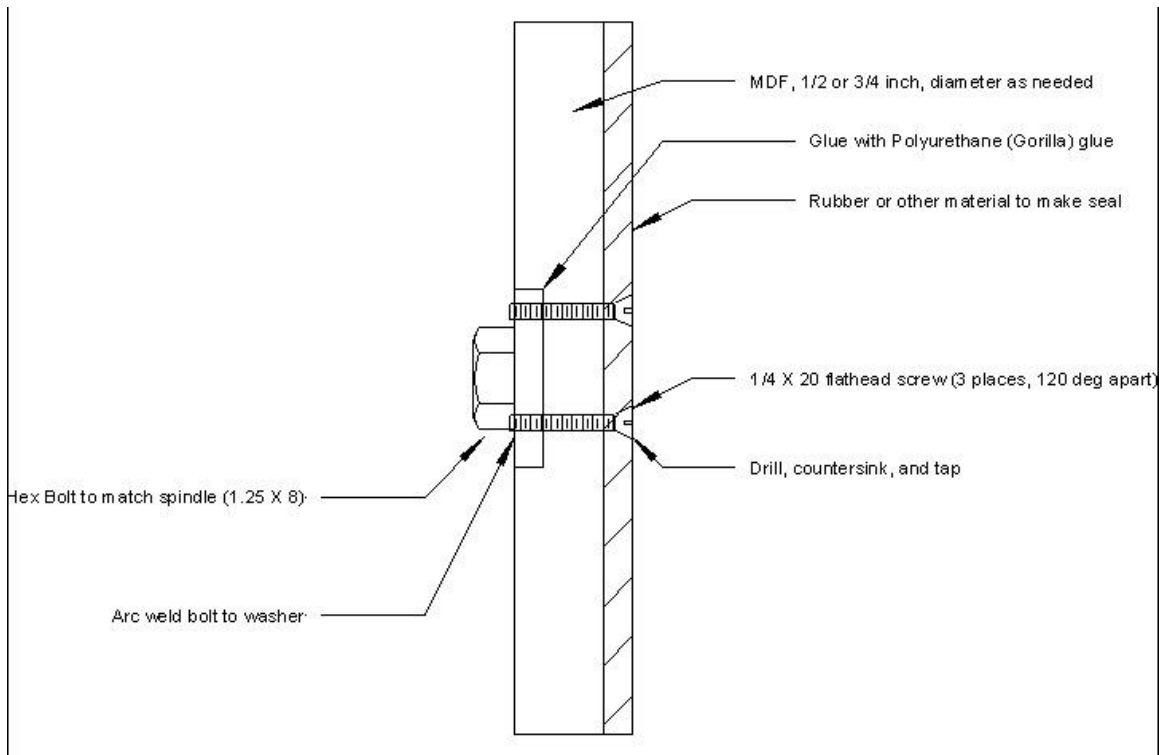

The figure above shows how to make a simple flat vacuum chuck. Purchase a nut that matches the threads on your spindle. Weld the nut to a washer (so you can space the screws out some distance away from the spindle and get more strength). Arc welding is almost mandatory here, a gas welder will heat the whole nut and may cause unacceptable distortions (and it will take forever).

A good diameter for this chuck is 12 to 18 inches, or the maximum your lathe can tolerate, which ever is smaller.

Mount a piece of  $\frac{1}{2}$  or  $\frac{3}{4}$  inch MDF or LDF on a faceplate and turn a recess about  $\frac{1}{8}$  of an inch deep whose diameter is very close to that of the OD of the washer (about  $\frac{1}{16}$  " oversize is good). You may also wish to turn it approximately round so you don't get your knuckles smacked by a sharp corner, but you will turn it round again in a later step. Glue the washer into the recess using urethane glue or epoxy or even RTV. Drill 3 (or 4) holes and tap them to accept mounting screws – I use  $\frac{1}{4}$  X 20 TPI flat head screws. You want to use flat head screws so they can be flush with the MDF surface when countersunk. If you choose to let the glue dry before drilling, then use the tail stock to apply pressure to the nut to hold it against the MDF.

It may be possible to omit the screws, but I would be loathe to do so – I would hate to discover that the glue sheared during some operation causing the MDF to separate from the washer/nut assembly. Once the screws are installed and tightened, put the assembly onto the lathe and start the lathe. Use a sharp skew to trim the MDF so it is running true – you will want to trim the edges to make it round, and you will want to cut the face so that it doesn't wobble. Use a straight edge if you like to make sure it is reasonably flat. Then use a drill, or a skew and cut a hole through the MDF in the center so the vacuum has a place to suck through. This hole is not shown in the figure.

When you are done, spray on a layer of adhesive and cover the face of the MDF with closed cell foam. An old mouse pad will work, as will router table rubber, wetsuit rubber, and so on. You now have your first vacuum chuck.

This configuration is useful for items with a flat top, such as a bowl or box.

#### **4.4.1.1 A useful variation on the flat chuck**

If you make another flat chuck like the one above, but with the disk diameter about 4 or 5 inches, you can make an internal bowl chuck. After assembling it and trimming it so it is concentric and flat, glue a piece of rubber pad that is at least one inch in radius (or two inches diameter) larger than the MDF disk onto the MDF. You will now have an MDF disk with rubber hanging off the edge.

Put this mess on the lathe after the glue is dry and bring the speed up until the rubber is held fairly flat by centrifugal force. Use a sharp parting tool to trim the rubber round leaving it extending at least an inch (but not more than 2 inches) beyond the edge of the MDF.

The extra rubber will conform nicely to the inside of a bowl or other object that is not really round, or that has a natural edge and thus cannot be held with the flat chuck.

#### **4.4.2 A raised chuck**

Construct one or more flat chucks as described above, but don't glue any rubber to them. Make one about 5 inches in diameter, another about 7. Get a short (one foot will do) length of 4 inch PVC pipe and of 6 inch PVC pipe.

Mount the 5 inch chuck you just made on the lathe and cut a very shallow groove in it with a parting tool at about 4 inches diameter. Test with the 4 inch PVC to see if it is exactly right, and adjust until it is a very close fit to the PVC. Then, cut the groove  $\frac{3}{4}$  of the way through the MDF. Press the PVC into the groove, put a piece of wood across the far end and hold it in place with the tail stock. Cut it with a cut off tool 4 to 6 inches from the MDF.

Then glue the PVC pipe into the groove using epoxy or urethane glue (not RTV). Put some glue of your choice into the slot, reverse the PVC so that the edge you just cut gets pressed into the slot, and push it in. You will want to make sure that the pipe is pretty well centered, so after pressing the PVC into the slot, rotate the lathe by hand and note the runout of the PVC.

The easiest way to do this is to move the tool rest close to the end of the pipe and rotate the lathe by hand. When the pipe the closest to the rest, move the rest so it just touches the pipe. Then turn the work 180 degrees with the handwheel. The pipe will now be at it's farthest location. Move it half way back to the tool rest and repeat the process. You can stop when the total runout is less than 1/16, in fact 1/8 is probably ok.

After the glue dries you can either build up a lip using hot melt (see Soren Berger's note on seals, below) or you can make a second MDF disk with a groove that matches the PVC and glue it on the headstock end. When the glue dries a second time, you can turn

the second MDF disk into a lip (about 3/4 inch wide) that will be concentric to the lathe axis even if the PVC pipe is not perfectly concentric.

Repeat for the 6 inch pipe. Note that you can make these as large as you see the need.

## 4.5 Seals for the chucks

### 4.5.1 Soren Berger's note on seals

Soren Berger posted the following note on rec.crafts.woodturning. The author has tried this approach, but has found that fully cooled hot-melt adhesive is too rigid for all but the most perfectly round objects. So, if there is any warping in the item, a more resilient seal would be beneficial. However, if the adhesive is allowed to cool somewhat but not totally, then it works as Soren describes.

*The best seal material for the leading edge of any vacuum chuck is hot glue. To use this just turn a groove in the front edge of your MDF or PVC chuck generously fill this with your hot glue gun, allow to cool then turn this into the required shape to fit object you wish to hold. You now have a seal which has some give, is slightly tacky and easily repaired.*

*Cheers Soren*

### 4.5.2 Other seal material

For the seal, you may wish something resilient like rubber, or you may want something pretty hard. It depends on whether the item (bowl or whatever) is really round or has a flat (planar) edge to seal to, or if it is elliptical or not flat. Table 7 identifies other materials and some thoughts about them.

**Table 7 - Seal Materials**

Material	Comment
Artificial chamois (for washing cars)	Good seal to a flat/round surface. Will provide a solid base for work
Closed cell foam (mouse pad, wet suit)	More conformal, will seal to more irregular or imperfect work. But because it is flexible, the work itself can move a bit, so you will have to use much lighter cuts
Neoprene rubber	Like the chamois, it is a rigid material that won't conform much to irregular surfaces
Other foam	Make sure the foam is closed cell. An open cell foam will allow air to pass and you will have a major vacuum leak.
Styrofoam	Haven't tried it, but it's pretty brittle.

Leather	See Chamois
Vinyl	Not a good choice, too rigid to seal to any but the most perfect surface.

You can get "O" ring type belts for vacuum sweepers at the super market for about \$1.98 for 2 that are approx. 4 inch in diameter and fit nicely on the end of a piece of PVC to become a vacuum chuck.

## 5 Additional information and sources

This section contains a selection of sources and additional information. The author makes no recommendation regarding any particular source.

### 5.1 The VacuuMaster Chuck

Jennifer Shirley recently posted at the Badger Pond forum a review of the VacuuMaster vacuum adapter system <http://www.sierramold.com/Wvchuck.htm>. This is the one that Bill Grumbine was involved with and works on lathes whether or not they have a through spindle. Though the VacuuMast has been discussed here before, I thought Jennifer provided a good review and asked for her permission to post it here on the NG.

Lyn

0500	VacuuMaster Vacuum Chuck Assembly	\$289.00
------	-----------------------------------	----------



Sierra Mold encourages your questions, comments, suggestions and feedback about our products

**Call Us:**  
**775 882-3500**  
**Fax Us:**  
**775 882-2502**

**Write Us:**  
**Sierra Mold**  
**1558 Forrest Way**  
**Carson City,**  
**Nevada 89706 -0311**  
**USA**

**E-mail Us:**  
[info@sierramold.com](mailto:info@sierramold.com)

The following is a review of this product from the web:

*Date: Saturday, 2/2/02, at 3:03 a.m.*

*Hello All,*

*Recently I had the privilege to "test drive" a new vacuum chuck that's now on the market. It's called the VacuuMaster and it's made by Sierra Mold Corp. out of Carson City, Nevada. I thought I'd do a little review to let you all know my opinions on this chuck and it's performance. Let me first say that this chuck is suitable for both solid headstocks and hollow headstocks. I'm not sure if that's the correct terminology, but*

*it's all I can think of at the moment. If you use a knockout bar to remove a spur drive it's hollow. if you don't it's solid : )*

*For anyone who is not familiar with what a vacuum chuck is used for, it's main purpose is for reverse chucking of bowls or platters after they are hollowed out. Most turners like to finish off the bottom of their bowl so as not to show signs that a mechanical chuck was used. An example would be a tennon or foot with scarring from the jaws of a chuck or a recess from jaws that were expanded inside them. I'll be the first to admit that I have many bowls sitting on my shelves with recesses in them, but as I learned that I could make them look better by easing the recess or by finishing or completely removing the foot, I've since struggled with the various options to reverse chucking. Some of the options I've tried are Cole jaws which have their limitations, a compression chuck that is very difficult to re-center the work piece, a jamb chuck etc. I know one turner who cuts a groove in a 2x disc and then duct tapes the bowl to it. Whatever works? Granted, almost every form of reverse chucking has its limitations, even the vacuum chuck...but once you try one you'll be hooked. Let me just say.. it's just one more aspect of the turning addiction!*

*Right out of the packaging I could tell the VacuuMaster was made with the utmost of scrutiny. I don't know a lot about machine work but I know enough to be able to tell if the manufacturer cares about quality control. The chuck was beautifully machined and finished, looked great and was substantial in weight. It just "felt" good. The package that I received from Sierra Mold consisted of the chuck body, an adapter to fit my General 26020 lathe, two different size bells. a 3.5" and a 5"(the bells are what sit inside the bowl. Different sizes for different size bowls) a stop rod to drop between the ways to allow forward and reverse turning of the piece, a 1/4hp Gast vacuum pump with all of the necessary gauges, fittings and tubing and a full set of instructions for operation of the pump and the chuck.*

*The first bowl I used the VacuuMaster on was a walnut bowl approximately 10" in diameter and about 5" deep. After turning the pump on I put the bowl on the bell and brought the tailstock up to help me find center. After a couple of quick adjustments I turned the pump up full and pulled the tailstock away. Wow! I was amazed that the bowl just stuck there like magic! I pulled hard on the rim of the bowl and it would not budge. So away I went on the tennon that was left for the Stronghold chuck to hold onto. It seemed strange not to have some sort of apparatus in my way and obstructing my workspace. It was wonderful! I could run the lathe at higher speeds than I normally do when I use my home made compression chuck or a jamb chuck giving me cleaner cuts and a much nicer finish on the bottom.*

*The VacuuMaster ran smooth and quiet and appeared to have no run out what so ever. The bells that came with my test kit were the 3.5" and the 5". Sierra Mold offers two other sizes 8" & 10", but I have a feeling the two smaller sizes would cover most of the applications the average turner would face. One of my main concerns was the depth at which the bells could reach inside the bowls. The depth of the bells was approximately 2.5", which was fine for most of the bowls I used them on, however if you had a deep bowl to reverse it might interfere with the tubing from the chuck body. When I voiced my concerns regarding this matter to the powers that be at Sierra Mold I found out that some deeper bells are in the works right now : )*

*In conclusion I have to say that the VacuuMaster is a wonderful piece of equipment that would be a great addition to any turner's accessories stash : ) If you'd like to read and see more about the VacuuMaster just put your pointer here and click!*

*A huge thanks to Sierra Mold for allowing me to take the VacuuMaster for a "spin"!*

*(traditional disclaimers go here)*

*Jennifer*

*2/2/02*

## **5.2 Complete Vacuum Chuck kits and Rotary Fittings**

## 5.2.1 The Woodturners Catalog

(Craft Supplies USA), 1-800-551-8876, [www.woodturnerscatalog.com](http://www.woodturnerscatalog.com) has a kit called the Artisan Vacuum Chuck System. They sell the system without a vacuum pump for \$125 in the 2001/2002 catalog. This includes 2, 4, and 6 inch vacuum rings with a foam seal, a base disk, and a rotary adaptor that includes a threaded rod to fit through the headstock spindle, a rotary vacuum fitting and a #2 MT vacuum fitting for the spindle. A Gast 1/3 HP vane pump is sold separately.

## 5.2.2 Oneway



The rotary adaptor threads onto the outboard spindle of the lathe and provides a place to attach the vacuum hose. Using double ball bearings, the Rotary Adaptor keeps the hose from twisting with the rotation of the lathe. The vacuum is pulled through the hole in the headstock spindle (your lathe must have a hollow spindle with no cross holes). Your lathe must have an outboard spindle thread for the Rotary Adaptor to thread onto. Since the Rotary Adaptor uses the same insert as the Stronghold chuck, an insert must be purchased separately to use with the Rotary Adaptor.<sup>4</sup>



## 5.2.3 E-Z Vacuum Adapter

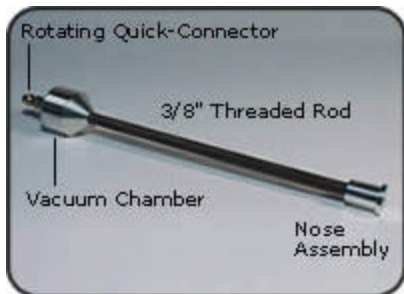

This Vacuum Adapter provides a conduit to pull the vacuum through the headstock spindle. It was designed by a professional woodturner to fit onto any lathe that has a #2 Morse Taper and a hollow headstock spindle with a 3/8" diameter hole or larger running through it. The vacuum adaptor provides a conduit for the air to go through the spindle to a user made fixture mounted on a faceplate.



The self-contained Vacuum Chamber has a quick-connector (fits standard air fittings) pressed into a sealed ball bearing that compensates for the revolving spindle of the lathe. This unit centers in the hole at the back end of the lathe spindle.

The Nose Assembly has vacuum holes and an adjustable or removable center point. It fits loosely into the Morse Taper of your lathe and beds out against the work end of the lathe

<sup>4</sup> <http://www.packardwoodworks.com/> 1-800 683-8876 Packard Woodworks, PO Box 718 Tryon, NC 28782.

spindle.

An 18" long threaded tube carries the air through the spindle while connecting the vacuum chamber and the nose assembly. They are held against each end of the lathe spindle. The workpiece is held in a user made fixture held on a faceplate or using the Drum Chucks we offer on this page.

The vacuum can be supplied by either a vacuum pump (not a shop vac) or a Venturi vacuum system that works with your air compressor.

#### 5.2.4 Pisco Rotary Joints

The following is from a company press release. The author has not examined this product.

Pisco's standard Rotary Joint incorporates a single bearing for fast swiveling connections, and is ideal for air and vacuum applications. The standard joint includes a service pressure range of 0~150psi, a negative pressure range of -29.5in.Hg, and is available in 5/32", 1/4", 5/16", 3/8" or 1/2" O.D. with a maximum Rpm of 500.

Pisco's High Rotary Joint employs two bearings, and is suitable for high-speed swiveling and swinging connections not covered by the standard model. The High Rotary Joint is also used in air and vacuum applications. The High Rotary Joint has a service pressure range of 0~150psi, and a negative pressure range of -29.5in.Hg, and is available in the following tube sizes: 5/32", 1/4", 5/16", 3/8", or 1/2" O.D. with a maximum of 1500 Rpm's.

For more information on Pisco's Quick-Fitting Rotary Joints, or any other products from Pisco contact them at Pisco U.S.A., Inc., 2228 Landmeier Rd., Elk Grove Village, IL 60007, Phone: (847) 427-1314, Fax: (847) 427-1317.

### 5.3 Thomas pumps

<http://www.thomaspumps.com>

Thomas Industries Inc.  
1419 Illinois Avenue  
P.O. Box 29  
Sheboygan, WI 53082-0029  
Tel: 920-457-4891  
e-mail: [rtaylor@thomasind.com](mailto:rtaylor@thomasind.com)

### 5.4 GAST pumps

Gast Manufacturing Inc., a Div. of IDEX Corp.  
P.O. Box 97  
Benton Harbor, MI 49023  
Tel: 616/926-6171  
Fax: 616/925-8288



A UNIT OF IDEX CORPORATION



Web: <http://www.gastmfg.com>  
E-mail: [marketing@gastmfg.com](mailto:marketing@gastmfg.com)

## **5.5 Building a Longworth Chuck**

### **The Longworth Chuck**

by Larry Pope

*[This material is from Woodturning Magazine No. 3, Spring 1991. It is published here for woodturners around the world to share by permission of the publishers:*

*WOODTURNING, GMC Publications, 165 High Street, Lewes, East Sussex, BN7 1XU ENGLAND. Telephone 01273 488005. Facsimile 01273 478606. We thank them for sharing.]*

#### **5.5.1 Introduction**

I am a member of the Northshore Woodturners Guild in New Zealand. Like many others, we exchange our newsletter with other clubs, including some in Australia. They in turn send us copies of their newsletters to our mutual benefit.

I don't remember the date, but I think it was early in 1989, that a copy of a bulletin from the Hunter Valley Club in New South Wales, Australia, was brought to my attention by our Club Editor, Nelson Rundle. It contained part one of a two part article by a Mr. Longworth on a self centring chuck which held the rims of bowls, enabling the turner to complete work on the base of the bowl. Quite a useful tool for removing all evidence of how a bowl was originally chucked when leaving bowls with screw holes, chuck recesses, etc. in the bottom is no longer acceptable.

Unfortunately Mr. Longworth died shortly after the first article and the second part was never completed, The first article contained a rather rough drawing and I was asked if I could possibly draw up something more precise I decided to go further than that and to actually make the chuck. After one or two experiments with compasses and protractor, I eventually produced a three jaw model which created a lot of interest among our members, and several more chucks were made from the plans I had produced.

Interest was also shown by visitors to our club who went away, made a few modifications and, as I see from our National Quarterly Magazine, have almost claimed it as their own. The inspiration however was that of Mr. Longworth of Hunter Valley and to him should go all the praise. It is interesting to note that Mr. Longworth's own club wrote to us to obtain plans of the chuck which we had made available to our members. I have no doubt that eventually it will be produced commercially, probably in metal with a multitude of jaws. However make one yourself, it's not difficult.

You will need

- a. A wood lathe.
- b. A router with a swing arm so that you can cut out an arc of a circle. Most routers have a little jig which attaches and allows this facility.

- c. An electric drill
- d. A screwdriver

### 5.5.2 Building Material

- A. A small face plate (not more than 100mm [4"]). Use a larger face plate if you wish but the jaws can come no closer than the width of the face plate. So the smaller the face plate the smaller the bowl which can be worked,
- B. A small wooden block 30mm [1-1/8"] thick and the same length and breadth as the face plate
- C. Piece of (6mm [1-1/4"]) good quality plywood,
- D. Piece of (20mm [3/4"] thick) close density particle board, plywood or wood board The size of the latter will depend on the maximum size of the bowls to be used. If the chuck is to be operated in board of the lathe its dimension will be limited to the maximum throw of the lathe. Otherwise, obviously, it will not fit on the lathe.
- E. Four gutter bolts with wing nuts 6mm [1/4"] diameter. Note that you will need the same diameter router bit for cutting the slots. The length of the screws will be the sum the thickness of the plywood plus the thickness of the particle board, plus the thickness of the rubber jaws, plus about another 20mm [3/4"].
- F. Rubber jaws. I use doorstops. Sink plugs are another good alternative. Any rubber shape with a hole through it.

### 5.5.3 Construction

1. Screw the wooden block B firmly to face plate and mount face plate on the lathe. Remove surplus wood until you have a disc the same size as the face plate. Check that the face of this disc is true. If it isn't, clean it up.
2. Take the piece of plywood C and the piece of particle board D and cut each into a circle. The diameter should be close to the maximum size you require the chuck to be. This doesn't have to be precise as you will true it up later on the lathe. The best method of cutting the wood is by using a bandsaw, a jig saw, a coping saw, a fret saw or any saw in that order.
3. Glue and screw the face plate and wood block to the centre of the particle board disk. Get it as accurate as possible but don't get neurotic about it.
4. Place the face plate in a vice, or between two pieces of timber, with the particle board uppermost. Now tack the piece of plywood to the particle board. Avoid tacking through the centre of the piece. Use sufficient tacks to make it secure, Don't use too long a tack as they will have to be removed later. Make sure that the heads of the tacks do not protrude or else later on they will impede the movement of the router.
5. Mount the chuck on the lathe and clean up the edges so that we have two precise disks. Using a pencil, and with the lathe rotating at slow speed, accurately locate the centre of the disk. It Is very Important that you locate the exact centre, so take your time over this. Now remove the chuck and mount in the vice, or across two pieces of timber, as previously. Make sure it is in a stable and comfortable position for you to work on.
6. From here on it all gets a bit nerve wracking. We are going to make a 4 jaw chuck, It

would be better if it were a 6 or more jaw chuck. The more jaws the more firmly it will grip. However a 4 jaw works well enough and is more simple to describe. One day I will make one in metal and make it a 10 jaw.

Through the centre draw two diameters each at right angles to the other. Now draw three circles around the centre:

1. One the same diameter as the face plate.
2. One 21 mm [13/16"] in from the outer edge,
3. One midway between the two circles just drawn.

If you don't have a compass large enough then just mark along one of the diameters the radii required, Then remount the chuck in the lathe and, resting a pencil on the tool rest at each marked spot. rotate the lathe at a very slow speed and describe the circles. Then remove the chuck and set up as before.

7. At the intersection of the mid circle with each diameter, a small indentation should be made. There are four of them (C1, C2, C3 and C4 as shown in Figure 1). These points should be very accurately marked as they are the centres about which the router will rotate. So take a lot of care here.

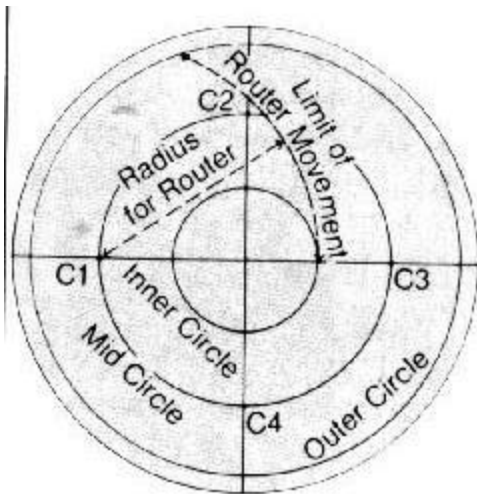

**Figure 1. Showing Router Movement.**

8. Now prepare the router for use. The router bit needs to be the same diameter as the gutter bolts. It will need to be deep enough to cut through both the plywood and the particle board. Set it up so it will swing about a centre. The radius of the swing is from the centre just calculated to a position just past the other side of the inner circle. The slot so made should not enter the inner circle but just graze the edge, Set the radius carefully because once you have started, you may not change it or allow it to change. Figure 2 shows the direction of cut for a chuck which is to be used inboard of the lathe. Reverse the direction if it is to be mounted outboard. (Anti-clockwise instead of clockwise.)

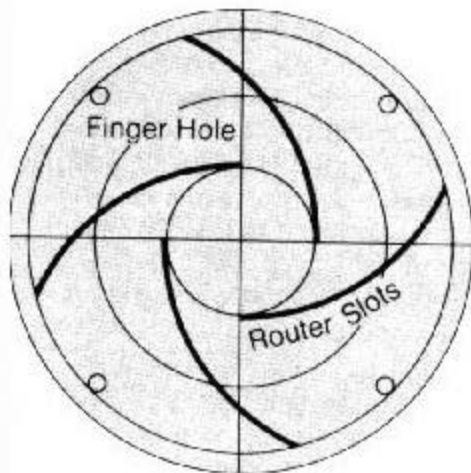

**Figure 2. Showing Router Slots.**

Now begin cutting the slots. They begin at the outer circle and finish when the router reaches the opposite side of the inner circle. Make sure you do not exceed these positions. Make sure also that the point of radius of the router is correctly located. Increase the depth of each cut slowly. Take much time and care over this stage of the chuck's construction. Its ultimate accuracy will depend on how well you do this routing. Continue cutting each slot until eventually you come through the other side.

9. When the routing is completed, you must cut several finger holes. The purpose of these is to assist in the rotation of the chuck disks when positioning the bowl to be worked. Make four holes, about 15mm [5/8"] across, near the edges in an area well away from the slots. Lastly, drill a hole through the centre of the plywood disk through the particle board and into the wood block. Ultimately the plywood disk will be located on the particle board disk by a screw. The first drilling should be deep enough to take the length of the screw and no wider than is necessary to allow the screw to bite into it. Now use a drill bit the exact diameter as that of the screw. It is essential to have a snug fit. Drill only through the plywood disk.

10. Now remove the tacks holding the plywood disk. Rotate the plywood disk. If you have cut accurately, each set of slots will line up exactly with the next set. Lightly sandpaper the slots and ensure that the gutter bolts will move easily within them.

11. Lightly grease the surface of the particle board and place the plywood disk back onto the particle board but in reverse order to what it was before.

The upper surface is now against the particle board and its other side is now uppermost. Screw the plywood disk to the particle board disk through the centre until the screw is fully home but still allows the upper disk to move freely. Now assemble the jaws as shown in Figure 3, with the wing nuts to rear. The chuck is now completed.

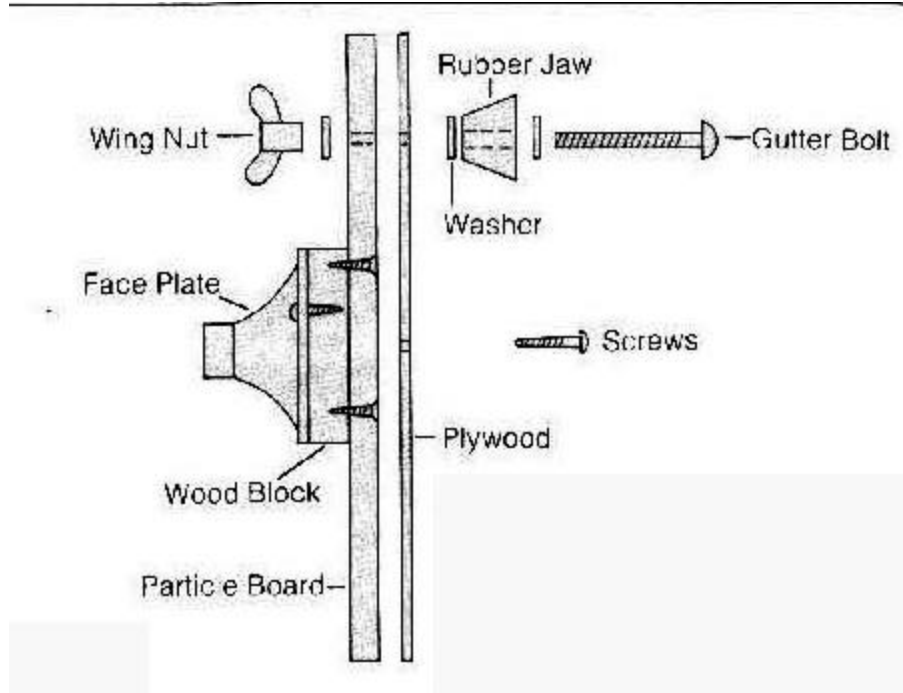

**Figure 3. Shows the assembly of the chuck.**

12. Place the chuck back on the lathe and, with the gear ratio at its lowest speed, start up the lathe. If the wing nuts have not been tightened, the jaws will move towards the centre ... a safety factor which will ensure the chuck will always have some degree of grip on your bowl. Note that the previously, oh so obvious jaws have now become a blur. I guarantee that, the first time you use the chuck, you will get a smack across a finger from one of them. For this reason always run the machine at slow speed. A bruised finger is better than a broken one.

13. Now get one of your most least liked bowls to try it out. If the edge of the bowl turns out, apply the jaws to the outer edge of the bowl. If the outer edge of the bowl turns inwards, apply the jaws to the inside of the bowl edge (Oh bliss, no bruised fingers). Place the chuck on a bench and lay the bowl on it. Bring the jaws to the edge of the bowl using the finger holes, and begin to tighten the wing nuts, a little at a time, until the bowl is firmly gripped. Now place the chuck back onto the lathe and bring the tail stock up as a safety measure. Position the tool rest and start the machine. It should run true.

#### Indispensable

Until you get used to the chuck, use a light scraper for your initial work and keep the tail stock in position for as long as possible. Having given it a light scraping, try a gouge and see how it goes. Don't make deep cuts. you don't want to risk a dig in and the whole thing coming off the chuck, I have ruined two masterpieces on this chuck, so always have a healthy respect for it. When you have got the hang of it you will find it indispensable. Happy turning!

# **Building a Vacuum Chuck System for Woodturning**

by

William Noble

March 2002

## Contents

Building a Vacuum Chuck System for Woodturning .....	1
1 Introduction.....	2
1.1 Why do you need a vacuum chuck .....	3
1.2 What are the alternatives to a vacuum chuck.....	3
1.3 What will it cost me? .....	4
2 How much vacuum is enough? .....	4
3 Types of Vacuum Sources .....	5
3.1 Venturis.....	5
3.2 Pumps.....	6
3.2.1 Vacuum Pumps: Basic Operation.....	7
3.2.2 Vacuum Stages.....	7
3.2.3 Oil-Less vs. Oil-Lubricated Vacuum Pumps .....	7
3.2.4 Positive Displacement Vacuum Pumps .....	8
3.2.5 Nonpositive Displacement Vacuum Pumps.....	9
3.3 Principles of Operation .....	9
3.3.1 Positive Displacement Pumps .....	9
3.3.1.1 Reciprocating Piston Pumps .....	9
3.3.1.2 Diaphragm Pumps .....	11
3.3.1.3 Rocking Piston Pumps .....	11
3.3.1.4 Rotary Vane Pumps.....	12
3.3.2 Nonpositive Displacement Pumps .....	14
3.3.3 Venturi Theory.....	15
3.4 Usage Considerations .....	16
3.4.1 Positive Displacement Pumps.....	16
3.4.1.1 Pump Recommendations .....	18
3.4.2 Nonpositive Displacement .....	18
4 How do you hook it up?.....	19
4.1 Setting Up a Positive Displacement Vacuum Pump .....	19
4.1.1 Muffler .....	20
4.1.2 Mounting the pump .....	20
4.1.3 Filter.....	21

4.1.4	Bleed Valve.....	21
4.1.5	Hose and Pipe.....	21
4.1.6	Gauge .....	22
4.2	A quick setup for a non-positive displacement pump.....	22
4.2.1	ADJUNCT TO VACUUM CHUCK .....	23
4.3	How to make your own rotary fitting .....	23
4.4	How to make the chucks .....	24
4.4.1	A flat chuck.....	24
4.4.1.1	A useful variation on the flat chuck .....	26
4.4.2	A raised chuck.....	26
4.5	Seals for the chucks.....	27
4.5.1	Soren Berger's note on seals .....	27
4.5.2	Other seal material .....	27
5	Additional information and sources .....	28
5.1	The VacuuMaster Chuck .....	28
5.2	Complete Vacuum Chuck kits and Rotary Fittings .....	29
5.2.1	The Woodturners Catalog.....	30
5.2.2	Oneway .....	30
5.2.3	E-Z Vacuum Adapter.....	30
5.2.4	Pisco Rotary Joints.....	31
5.3	Thomas pumps .....	31
5.4	GAST pumps.....	31
5.5	Building a Longworth Chuck.....	32
5.5.1	Introduction.....	32
5.5.2	Building Material.....	33
5.5.3	Construction.....	33

## 1 Introduction

This paper discusses the construction and theory of vacuum chucks for use on wood lathes. Vacuum chucks and vacuum holding devices are used in industry for a wide range of purposes, from lifting packages to holding items for machining. The discussion here is directed to the craft of woodturning and will generally avoid the other uses.

A vacuum chuck on a wood lathe is a device that can hold the work piece for final finishing. It is generally not suitable for holding something during initial shaping or hollowing.

### **1.1 Why do you need a vacuum chuck**

1. The short answer is that you don't really need one, but once set up it is a great convenience.
2. To finish off the bottom of an item, you can hold it with vacuum rather than a jam chuck or tailstock pressure. This helps you do better work.
3. For making multiple copies of an identical item, a vacuum chuck provides a quick, easy method of changing from one work piece to another.
4. It's easy, so it makes the work more fun – at least I don't like making jam chucks because I don't like throwing things away.

And anyway, it is really nice to be able to take just about anything and have it stick to your lathe while you turn it.

There are some limitations, however. If the item is very porous, air will pass through the walls of the item and it will not be held securely (or at all). If the item is very thin walled, the differential air pressure can crush it. And, it generally does not hold as securely as a scroll chuck or a faceplate.

### **1.2 What are the alternatives to a vacuum chuck**

If your goal is to be able to finish the foot of a bowl nicely, you have four alternatives.

1. Carefully part the bowl from the lathe and then finish the foot by hand or with power tools. This will work for any object, not just a bowl, but there are cases where it would be beneficial to be able to carve the inside of the foot on the lathe, which is largely impossible with this approach.
2. Reverse the bowl and hold it by its rim in a jam chuck. This of course, will not work for a natural edged bowl or any irregular object. It will allow you to work on the foot and turn its interior using the lathe.
3. Use a large scroll chuck to hold the bowl by the rim. As with the jam chuck, this will not work with an irregular object. The advantage over a jam chuck is that you don't have to keep making another one for each new piece you finish. An excellent design for a do-it-yourself chuck for this purpose is the Longworth chuck. <http://www.fholder.com/Woodturning/lwc-wtm.htm> contains construction plans for such a chuck, they are reproduced in section 5.5.
4. Hold the bowl (or object) in a vacuum chuck while you shape the bottom side of the foot.

The alternatives above are in order of increasing complexity and cost.

### 1.3 What will it cost me?

There is a list of commercial sources for the part you need at the end of this paper. The only expensive part is the vacuum pump. These can cost \$200 to \$400 new, but can frequently be found surplus or used for much less. Similarly, vacuum gauges can be found surplus for a few dollars, or bought new for \$15 to \$50. So, your expense will depend in large part to how much effort you are willing to spend to reduce expenses. A simple system build using your existing shop vacuum might cost almost nothing, whereas a system built using all new parts might cost around \$500. One of the goals of this paper is to give you enough information that you can make informed decisions about locating and selecting the parts for your vacuum chuck system.

## 2 How much vacuum is enough?

It depends on the size of the work. This may be counterintuitive, but larger work needs less vacuum. Why? Because it's air pressure that holds the work in place, and the air pressure is proportional to the area of the piece (technically, the contact area that is projected onto a plane perpendicular to the axis of rotation of the lathe). So, with the same vacuum, a 8 inch bowl will have 4 times the holding pressure as a 4 inch bowl, and 8 times the pressure of a 2 inch bowl.

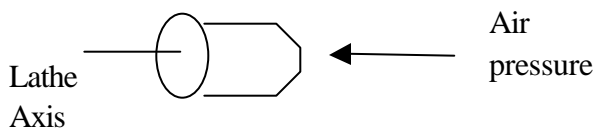

Air pressure is about 14.7<sup>1</sup> pounds per square inch at sea level, or 29.9 inches of mercury (or about 0.459375 PSI per inch of mercury). For historical reasons, vacuum is usually measured in inches of mercury, where 30 inches is considered a perfect vacuum. Of course for near perfect vacuums other units, such as the Torr are used, but we won't discuss them here.

Since air pressure varies with elevation, if you are in Denver, you will have less air pressure pushing your bowl against the vacuum chuck. Similarly, if there is a storm front coming and the barometer reads low, you will have less force. Remember, it isn't the vacuum that pulls the work, it's the outside air pressure that pushes it once you have removed the air inside the chuck so it can't push back.

Areas as a function of diameter is shown in Table 1, as you can see, there is a huge amount of pressure developed on a large bowl, enough to crush it if you are not careful. So, the high vacuum (if 20 inches is a high vacuum) is only needed with small objects. We won't delve here into cantilevered forces, but if you have a long thin object, it will move with sideways pressure despite the holding force below – this force is ONLY normal to the chuck (e.g. along the axis of rotation).

---

<sup>1</sup> STP, or Standard Temperature and Pressure is measured at 273.15K=0°C=32°F. IT is  $1.01325 * 10^5$

Pascals, or 1 atmosphere, or 14.7 pounds per square inch (PSI)

Diameter	Area (square inches)	Force on a bowl as a function of vacuum		
		5 in Hg	10 in Hg	20 in Hg
4 in	12.6	29	58	116
8 in	50.3	115.5	231	462
16 in	201.1	462	924	1848
32 in	804.2	1847	3694	7389

**Table 1 – The Force due to air pressure on a bowl held in a vacuum chuck**

There are a couple of considerations to keep in mind.

- First, the pump must have enough flow rate to actually produce the vacuum you need. This is why most systems include a vacuum gauge that is installed near the lathe so you can see what vacuum is actually being delivered to the chuck.
- Second, with a larger object the forces that can be produced are huge. It is certainly possible to crush the object with the force of the air. And if that happens there is a safety concern. If the lathe rotating when the object disintegrates, then pieces will be thrown from the lathe and can cause injury. Even if the lathe is not rotating, the force of the implosion can cause parts of the object to fly about at high speed. So, you need to be aware of the forces being developed. If you see the walls of your vessel start to deflect, reduce the vacuum.

### 3 Types of Vacuum Sources

#### 3.1 Venturis

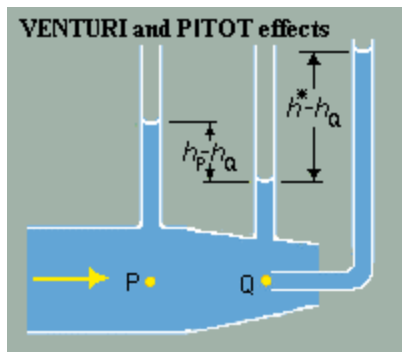

A venturi is a device that produces a vacuum from flowing air (or water). They are generally not suitable for our purposes, and are covered here for completeness.

As you can see from the table below, these devices use a goodly amount of shop air to produce the vacuum. They are also noisy (because of all the air flowing through them). Their value in some applications is that there are no moving parts, no electricity, and nothing to catch fire or burn. In other applications where there just happens to be plenty of moving fluid (for example, the carburetor of your car or the

fill nozzle on a gas pump), they are used for convenience.

**INCHES OF MERCURY (H.G.)<sup>2</sup>**

MODEL NUMBER	INCHES OF MERCURY (H.G.) <sup>2</sup>						AIR CONSUMPTION AT 60 PSIG
	0	5	10	15	20	25	
10	.9	.7	.5	.2	.15	0	1.5
10L	1.4	1.1	.8	.3	0	0	1.5
33	1.5	1.2	.9	.6	.3	0	2.5
15	2.2	1.7	1.3	.8	.4	.1	3.5
15L	3.0	2.0	1.5	.9	0	0	3.5
20/22	4.0	3.2	2.4	1.6	.8	.2	6.4
20L/22L	5.5	4.4	3.0	1.7	0	0	6.4
2030	6.9	5.5	4.0	2.0	1.0	0	6.4
30/32	10	7.0	5.0	2.5	2.0	.3	8.6
30L/32L	12	9.0	7.0	3.0	0	0	8.6

### 3.2 Pumps

<sup>3</sup>Equipment used to generate vacuum is similar to air compressors. It's even possible to generate compressed air or vacuum with the same machine, depending on how it is installed. Vacuum pumps generally can be considered as compressors in which the discharge, rather than the intake, is at atmospheric pressure.

Recall that the essence of air compression is the increased number of molecular impacts per second. Conversely, the essence of vacuum generation is the reduction of these impacts. The vacuum in a chamber is created by physically removing air molecules and exhausting them from the system.

Removing air from the enclosed system progressively decreases air density within the confined space, thus causing the absolute pressure of the remaining gas to drop. A vacuum is created.

Because the absolute maximum pressure difference that can be produced is equal to atmospheric pressure (nominally 29.92 in. Hg at sea level), it is important to know this value at the work site.

For example, a pump with a maximum vacuum capability of 24 in. Hg cannot generate a 24-in. vacuum when the atmospheric pressure is 22 in. Hg (as in Mexico City, for instance). The proportion of the air evacuated will be the same, however. This pump therefore will pull  $22 \times 24 / 29.92$  or  $22 \times 24 / 30 = 17.6$  in. Hg vacuum in Mexico City.

<sup>2</sup> <http://www.vac-cube.com/pages/pg8.html>

<sup>3</sup> This overview of vacuum pumps is extracted from the GAST "Vacuum and Pressure Systems Handbook", available as a PDF file from <http://www.gastmfg.com/pdf/vacpresshdbk.pdf>

### 3.2.1 Vacuum Pumps: Basic Operation

A vacuum pump converts the mechanical input energy of a rotating shaft into pneumatic energy by evacuating the air contained within a system. The internal pressure level thus becomes lower than that of the outside atmosphere. The amount of energy produced depends on the volume evacuated and the pressure difference produced.

Mechanical vacuum pumps use the same pumping mechanism as air compressors, except that the unit is installed so that air is drawn from a closed volume and exhausted to the atmosphere. A major difference between a vacuum pump and other types of pumps is that the pressure driving the air into the pump is below atmospheric and becomes vanishingly small at higher vacuum levels. Other differences between air compressors and vacuum pumps are:

- The maximum pressure difference produced by pump action can never be higher than 29.92 in. Hg (14.7 psi), since this represents a perfect vacuum.
- The mass of air drawn into the pump on each suction stroke, and hence the absolute pressure change, decreases as the vacuum level increases.
- At high vacuum levels, there is significantly less air passing through the pump. Therefore, virtually all the heat generated by pump operation will have to be absorbed and dissipated by the pump structure itself.

### 3.2.2 Vacuum Stages

As in compression, the vacuum-generating process can be accomplished in just one pass through a pumping chamber. Or several stages may be required to obtain the desired vacuum. The mechanical arrangements are also similar to those for air compression. The discharge port of the first stage feeds the intake port of the second stage. This reduces the pressure, and hence the density, of air trapped in the clearance volume of the first stage. The net effect is, using a diaphragm pump as an example, that the second stage boosts the vacuum capability from 24 to 29 in. Hg.

### 3.2.3 Oil-Less vs. Oil-Lubricated Vacuum Pumps

As with compressors, the application normally dictates whether an oil-less or oil-lubricated vacuum pump should be used. Either type may be used in many applications.

**Oil-Less** - Oil-less pumps are almost essential when production processes cannot tolerate any oil vapor carry over into the exhaust air. They also can be justified on the basis of avoiding the cost and time of regularly refilling the oil reservoirs. This is particularly important when the pumps are to be mounted in inaccessible locations.

Modern piston pumps have rings of filled Teflon, which provide hundreds of hours of duty, depending on ambient temperature and air cleanliness. Diaphragm and rocking piston pumps are designed to be oil-less.

**Oil-Lubricated** - The oil-lubricated types have distinct advantages if proper maintenance is provided. They can usually provide about 20 percent higher vacuums because the lubricant acts as a sealant between moving parts. And they usually last about 50 percent longer than oil-less units in normal service because of their cooler operation. They also are less subject to corrosion from condensed water vapor.

### 3.2.4 Positive Displacement Vacuum Pumps

Vacuum pumps fall into the same categories as air compressors do. That is, they are either positive displacement or nonpositive displacement machines. A positive displacement pump draws a relatively constant volume of air despite variations in the vacuum levels.

As with air compressors, the principle types of positive displacement vacuum pumps are the piston, diaphragm, rocking piston, rotary vane, lobed rotor, and rotary screw designs. The remarks below cover aspects that apply to vacuum applications.

**Reciprocating Piston Pumps** -The primary advantage of the piston design is that it can generate relatively high vacuums from 27 to 28.5 in. Hg-and do so continuously under all kinds of operating conditions. The major disadvantages are somewhat limited capacities and high noise levels, accompanied by vibrations that may be transmitted to the base structure. In general, the reciprocating piston design is best suited to pulling relatively small volumes of air through a high vacuum range.

**Diaphragm Pumps** -The diaphragm unit creates vacuum by flexing of a diaphragm inside a closed chamber. Small diaphragm pumps are built in both one- and two-stage versions. The single stage design provides vacuums up to 24 in. Hg, while the two stage unit is rated for 29 in. Hg.

**Rocking Piston Pumps** -This design combines the light weight and compact size of the diaphragm unit with the vacuum capabilities of reciprocating piston units. Vacuums to 27.5 in. Hg are available with a single stage; two-stage units can provide vacuums to 29 in. Hg. Air flows, however, are limited, with the largest model available today (a twin-cylinder model) offering only 2.7 cfm.

**Rotary Vane Pumps** -Most rotary vane pumps have lower vacuum ratings than can be obtained with the piston design: only 20 to 28 in. Hg maximum. But there are exceptions.

Some two stage oil-lubricated designs have vacuum capabilities up to 29.5 in. Hg. (Also see the section on medium-vacuum pumps.) The rotary vane design offers significant advantages: compactness; larger flow capacities for a given size; lower cost (about 50 percent less for a given displacement and vacuum level); lower starting and running torques; and quiet, smooth, vibration free, continuous air evacuation without a receiver tank.

**Rotary Screw Pumps** - Vacuum capabilities of rotary screw pumps are similar to those of piston pumps, but evacuation is nearly pulse-free. Lobed rotor vacuum pumps, like the corresponding compressors, bridge the gap between positive and nonpositive displacement units. Air flow is high but vacuum capabilities are limited to about 15 in. Hg. Capabilities can be improved with staging.

### 3.2.5 Nonpositive Displacement Vacuum Pumps

Like the corresponding compressors, nonpositive displacement vacuum pumps use changes in kinetic energy to remove air from a system. The most significant advantage of this design is its ability to provide very-high-volume flow rates- much higher than possible with any of the positive displacement designs. But because of their inherent leakage, these machines are not practical for applications requiring higher vacuum levels and low flow rates.

The principle types of nonpositive displacement vacuum pumps are the centrifugal, axial-flow, and regenerative designs. Single-stage regenerative blowers can provide vacuums up to 7 in. Hg with flows to several hundred cfm. Vacuum capabilities of the other designs are lower unless they are multistaged.

## 3.3 Principles of Operation

This section briefly describes how the various types of pumps work. Note - these descriptions are drawn largely from the [GAST vacuum and pressure systems handbook](#). The descriptions below apply to compressors, but they illustrate the operation of the equivalent vacuum pumps. If you are not interested in how these devices work, feel free to skip this section.

### 3.3.1 Positive Displacement Pumps

#### 3.3.1.1 Reciprocating Piston Pumps

This design is widely used in commercial air compressors because of its high pressure capabilities, flexibility, and ability to rapidly dissipate heat of compression. And it is oil-less.

Compression is accomplished by the reciprocating movement of a piston within a cylinder. This motion alternately fills the cylinder and then compresses the air. A connecting rod transforms the rotary motion of the crankshaft into reciprocating piston motion in the cylinder. Depending on the application, the rotating crank (or eccentric) is driven at constant speed by a suitable prime mover. Separate inlet and discharge valves react to variations in pressure produced by the piston movement.

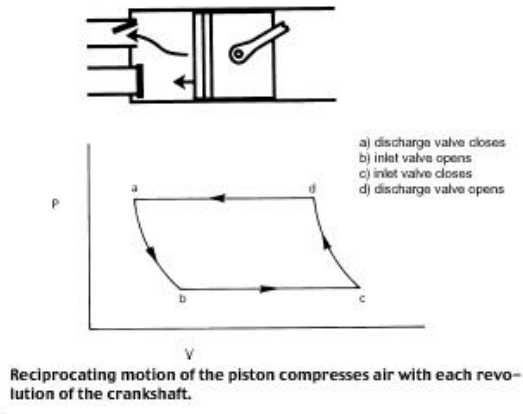

**Figure 1 – Reciprocating Piston Pump**

As the Figure 1 shows, the suction stroke begins with the piston at the valve side of the cylinder, in a position providing minimum (or clearance) volume. As the piston moves to a maximum volume position, outside air flows into the cylinder through the inlet valve. The discharge valve remains closed during this stroke.

During the compression stroke, the piston moves in the opposite direction, decreasing the volume of air as the piston returns to the minimum position.

During this action, the spring-loaded inlet and discharge valves are automatically activated by pressure differentials. That is, during the suction stroke, the piston motion reduces the pressure in the cylinder below atmospheric pressure. The inlet valve then opens against the pressures of its spring and allows air to flow into the cylinder.

When the piston begins its return (compression) stroke, the inlet valve spring closes the inlet valve because there is no pressure differential to hold the valve open. As pressure increases in the cylinder, the valve is held firmly in its seat.

The discharge valve functions similarly. When pressure in the cylinder becomes greater than the combined pressures of the valve spring and the delivery pipe, the valve opens and the compressed air flows into the system.

In short, the inlet valve is opened by reduced pressure, and the discharge valve is opened by increased pressure.

Some piston compressors are double-acting. As the piston travels in a given direction, air is compressed on one side while suction is produced on the other side. On the return stroke the same thing happens with the sides reversed. In a single-acting compressor, by contrast, only one side of the piston is active.

Single-acting compressors are generally considered light-duty machines, regardless of whether they operate continuously or intermittently. Larger double-acting compressors (usually watercooled) are considered heavy-duty machines capable of continuous operation.

Sizes of reciprocating piston compressors range from less than 1 hp to 6000 hp. Good part-load efficiency makes them very useful where wide variations in capacity are needed.

Their disadvantages? Reciprocating piston compressors inherently generate inertial forces that shake the machine. Thus, a rigid frame, fixed to a solid foundation, is often required. Also, these machines deliver a pulsating flow of air that may be objectionable under some conditions. Properly sized pulsation damping chambers or receiver tanks, however, will eliminate such problems.

In general, the reciprocating piston compressor is best suited to compression of relatively small volumes of air to high pressures.

### 3.3.1.2 Diaphragm Pumps

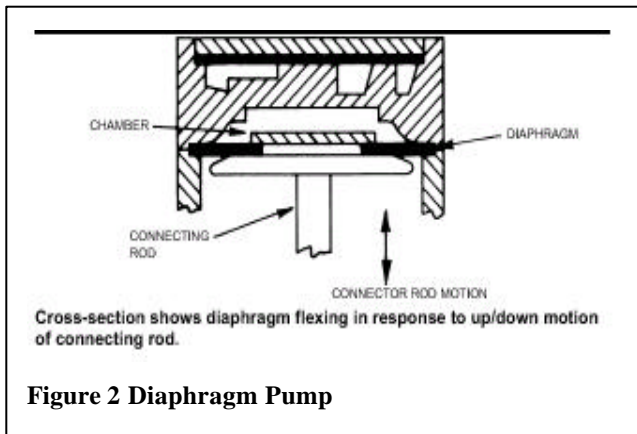

**Figure 2 Diaphragm Pump**

The diaphragm design is a modification of the reciprocating piston principle. An outstanding characteristic of the diaphragm design is that the basic compressing mechanism does not require a sliding seal between moving parts. A diaphragm compressor is also oil-less and it is therefore often selected when no oil contamination of the line or atmosphere can be tolerated.

Compression is performed by the flexing of a diaphragm back and forth in a closed chamber. Fig. 2 indicates how this flexing action is generated by the motion of a connecting rod under the diaphragm. Only a short stroke is required to produce pressure effects similar to those produced by a reciprocating piston in a cylinder.

Intake and discharge valves convert the volume changes produced by the reciprocating movement into pumping action. The reed-type valves work like those in the piston design.

### 3.3.1.3 Rocking Piston Pumps

The rocking piston principle (Fig.3) is another variation of reciprocal compression. In fact, it can be viewed as a combination of the diaphragm and piston principles. These pumps are called “Wob-L by Thomas, they are called Rock-R by GAST.

**Table 2 - Characteristics of Rocking Piston Pumps**

Performance	Features	Typical Applications	
<ul style="list-style-type: none"> <li>•Pressure to 175 psig (12 bar)</li> <li>•Vacuum to 29" Hg (31 mbar)</li> <li>•Air flow to 5.5 cfm (9,35 m<sup>3</sup>/h)</li> </ul>	<ul style="list-style-type: none"> <li>•Quiet</li> <li>•Oilless</li> <li>•Durable</li> <li>•Lightweight</li> <li>•Rugged Construction</li> <li>•Field Service Capability</li> <li>•Corrosion Resistant Models Available</li> </ul>	<ul style="list-style-type: none"> <li>•Oxygen Concentrators</li> <li>•Beverage Dispensing</li> <li>•Body Fluid Analysis</li> <li>•Automotive Suspension</li> <li>•Dental Vacuum Ovens</li> <li>•Vacuum Frames</li> <li>•Core Drilling</li> </ul>	 <p>Another reciprocating concept mounts a flexible cup at the top of the connecting rod and creates vacuum or pressure as the cup maintains a seal against the cylinder walls in a rocking motion.</p>



The rocking piston pump essentially mounts a piston rigidly (no wrist pin) on top of the diaphragm unit's eccentric connecting rod. This piston is surmounted by a cup made of Teflon, for instance. The cup functions both as a seal-equivalent to the rings of a piston compressor-and as a guide member for the rod. It expands as the piston travels upward,

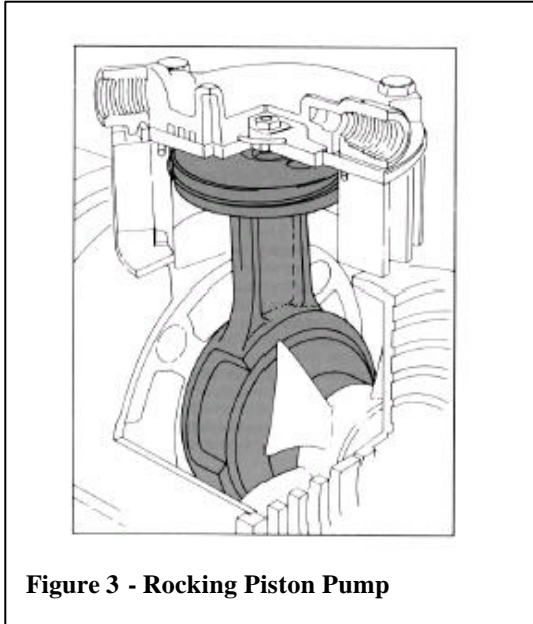

**Figure 3 - Rocking Piston Pump**

thus maintaining contact with the cylinder walls and compensating for the rocking motion.

The rocking piston compressor not only combines the mechanical features of the reciprocating piston and diaphragm types, but it also combines many of their best performance features. Like the diaphragm type, it is quiet, compact, and oil-less. Like the reciprocating piston unit, it can provide pressures to 100 psi.

The absence of a wrist pin is the key to the light weight and compact size of the rocking piston compressor. This makes the entire piston-connecting rod assembly much shorter and sharply reduces the overall dimensions and the weight of the unit.

**Table 3 TROUBLESHOOTING GUIDE for Rocking Piston Pumps**

Reason Possible	Pressure		Low vacuum	Excessive Noise	Overheating	Won't Start
	Low	High				
Dirty Filter	X					
Dirty Muffler			X			
Dirty Valves	X		X			
Bent/Damaged Valves	X		X			
Damaged/Worn Cup	X		X	X		
Leaky Hose	X		X	X		
Leaky Check Valve	X					X
Plugged Vacuum or Pressure Line		X	X		X	X
Low Voltage					X	X
Leaky Relief Valve	X					

#### 3.3.1.4 Rotary Vane Pumps

Some applications require that there be little or no pulsation in the air output, and perhaps a minimum of vibration also. The rotary vane compressor (Fig. 17) provides this. It is commonly used for moderately high air flows at pressures under 30 psig, although some rotary vane designs can provide pressures of 200 psig. Rotary vane units generally have lower pressure ratings than piston units because of more difficult sealing problems and greater sensitivity to thermal effects.

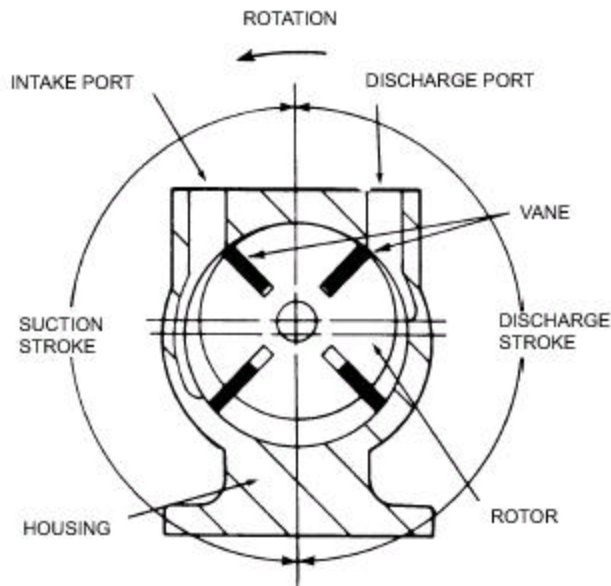

**In a rotary-vane compressor, the eccentrically mounted rotor creates smaller compression compartments as the vanes are pushed in by chamber walls.**

**Figure 4 - Rotary Vane Pump**

The Figure 4 above shows how pumping action is produced by a series of sliding, flat vanes as they rotate in a cylindrical case. As the rotor turns, the individual vanes slide in and out, trapping a quantity of air and moving it from the inlet side of the compressor to the outlet side.

There are no valves in the rotary vane design. The movement of the vanes controls the entire flow of air into and out of the individual compartments across separate inlet and discharge ports.

The rotor is mounted eccentrically -that is, not in the center of the casing. As the rotor rotates, the vanes are flung outwards and held against the body bore by centrifugal and pressure-loading forces. This creates a series of air compartments of unequal volume (because of the rotor's eccentricity). The compartments formed between adjacent vanes gradually become larger during the suction part of the cycle, and air is drawn into the compartment from the inlet port.

During the discharge portion of the cycle, the compartment volumes gradually become smaller, compressing the air. When a rotating compartment reaches the discharge port, the compressed air escapes to the delivery system.

The suction and exhaust flows are relatively free of pulsation because the inlet and discharge ports do not have valves, and the air is moved continuously rather than intermittently. Rotary vane compressors have certain significant advantages. In addition to providing smooth, pulse-free airflow without receiver tanks, they are compact (or, equivalently, offer high flow

### 3.3.2 Nonpositive Displacement Pumps

Also called "dynamic," "continuous-flow," and "velocity-type" compressors, this category comprises machines that use changes in kinetic energy to create pressure gradients. Kinetic energy is the energy that a body possesses by virtue of its motion. A fluid's kinetic energy can be increased either by rotating it at high speed or by providing an impulse in the direction of flow. The shop vacuum is a good example of this type of pump.

Unlike the positive displacement compressor, in which distinct volumes of air are isolated and compressed, a nonpositive displacement compressor does not provide a constant-volume flow rate over a range of discharge pressures. This is because the compartments are not isolated from each other and leakage between them increases as pressure rises.

Initial acceleration of the air produces a negative (suction) pressure at the inlet port, drawing air in. Partial deceleration of air at the discharge port converts some of the kinetic energy to pressure. Speed of the rotating impeller determines the pressure change. Higher pressure differences require either faster impeller speeds or additional stages.

The most important advantage of nonpositive displacement machines is their ability to provide very high mass flow rates. On the other hand, multiple stages are required to provide pressures above 4 or 5 psi and such machines are cost effective only for flow rates above 80-100 cfm. Nonpositive displacement devices are sometimes called fans or blowers rather than compressors. By some definitions, a fan provides less than 0.5 psi pressure and a blower between 0.5 and 10 psi. The distinction is frequently blurred in common use, however.

The three common types of nonpositive displacement compressors are centrifugal, axial, and peripheral (or regenerative). These names derive from the direction of air flow through their compression chambers.

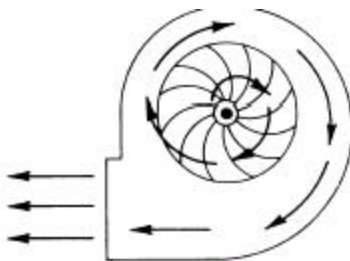

In a centrifugal blower, a rotating impeller sweeps air radially along the casing to the outlet.

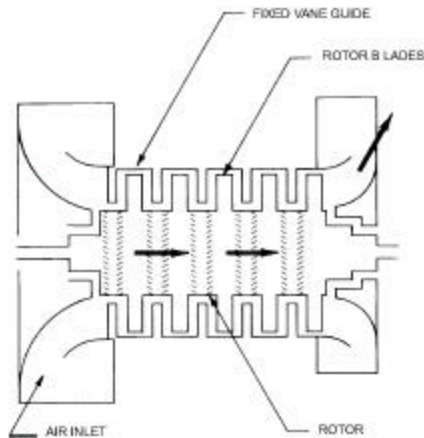

Air flows (arrows) through multistage axial flow blower. The fixed guide vanes between each stage keep air flow parallel to the axis of rotation.

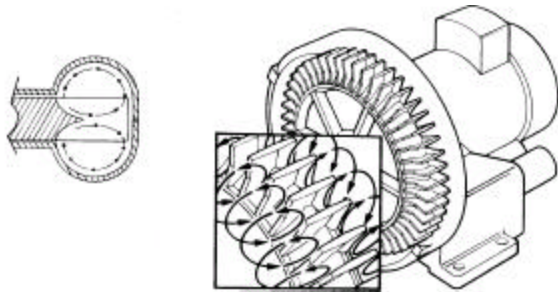

The arrows show the route air takes through a regenerative blower. Typical peripheral (regenerative) blower provides equivalent of multistage compression in a single revolution of the impeller.

### 3.3.3 Venturi Theory

You may feel free to skip this section unless you feel a desperate urge to mess with algebra and differential equations

Bernoulli's law indicates that, if an inviscid fluid is flowing along a pipe of varying cross section, then the pressure is lower at constrictions where the velocity is higher, and higher where the pipe opens out and the fluid stagnates. Many people find this situation paradoxical when they first encounter it (higher velocity, lower pressure). The well-known Bernoulli equation is derived under the following assumptions:

fluid is incompressible ( density  $\rho$  is constant );

flow is steady:  $\frac{\partial}{\partial t} = 0$

flow is frictionless ( $t = 0$ );

along a streamline;

Then, it is expressed with the following equation:

$$\frac{p}{\rho \cdot g} + \frac{v^2}{2 \cdot g} + z = h^* = \text{const.}$$

Where (in SI units):

$p$  = fluid static pressure at the cross section in  $N/m^2$ .

$\rho$  = density of the flowing fluid in  $kg/m^3$

$g$  = acceleration due to gravity in  $m/s^2$  (its value is  $9.81 m/s^2 = 9810 mm/s^2$ )

$v$  = mean velocity of fluid flow at the cross section in  $m/s$

$z$  = elevation head of the center of the cross section with respect to a datum  $z=0$

$h^*$  = total (stagnation) head in  $m$

The terms on the left-hand-side of the above equation represent the pressure head ( $h$ ), velocity head ( $h_v$ ), and elevation head ( $z$ ), respectively. The sum of these terms is known as the total head ( $h^*$ ). According to the Bernoulli's theorem of fluid flow through a pipe, the total head  $h^*$  at any cross section is constant (based on the assumptions given above). In a real flow due to friction and other imperfections, as well as measurement uncertainties, the results will deviate from the theoretical ones.

In our experimental setup, the centerline of all the cross sections we are considering lie on the same horizontal plane (which we may choose as the datum,  $z=0$ ), and thus, all the 'z' values are zeros so that the above equation reduces to:

$$\frac{p}{\rho \cdot g} + \frac{v^2}{2 \cdot g} = h^* = \text{const.}$$

(This is the total head at a cross section).

### 3.4 Usage Considerations

This section provides an overview of the key considerations in choosing one type of pump over another.

#### 3.4.1 Positive Displacement Pumps

The tables below are a good guide to the range of pumps and their selection factors. These tables are from the [GAST vacuum and pressure systems handbook](#). They are typical of what is found in pumps by other manufacturers also.

A good assumption for our vacuum chuck application is that you would like 20 inches to 25 inches of vacuum available at the pump.

**Table 4 Vacuum Ratings and Applicable Vacuum Pumps**

<b>Max. Vacuum Rating (In. Hg)</b>	<b>Types of Vacuum Pumps</b>
<b>Continuous</b>	
27.5 to 28.5	Piston (multistage)

25.5 to 29	Rocking piston
24 to 29	Diaphragm (single & multistage)
10 to 28	Rotary vane (oil-lubricated)
15 to 26	Rotary vane (oil-less)
7	Regenerative peripheral blower

**Table 5 Pump Capacities and Applicable Vacuum Pumps**

Vacuum Pump Types	Maximum Vacuum Level (in. Hg)		Range of Capacities (CFM Free Air at 0 in. Hg.)	
	Continuous	Intermittent	Smallest	Largest
Piston	27.5-28.5	-	1.3	10.5
Rocking Piston	25.5-29.0	-	1.22	2.7
Diaphragm	23.5-29.0	-	0.49	3.6
Rotary Vane (oil-lubricated)	10-28	25-28	1.3	55
Rotary Vane (Oil-less)	15-27	15-27	0.35	55

**Table 6 Availability of Motor-Mounted Vacuum Pumps**

Vacuum Pump Type	Range of Open Capacities (cfm)	Motor H.P. Requirements
Piston (1-stage)	1.8 to 10.5 cfm	1/6 to 3/4
(2-stage)	1.15 and 2.30 cfm	1/8 and 1/4
Rocking piston (1-stage)	1.12 to 1.6 cfm	1/8 to 1/4
(2-stage)	1.25 to 2.7 cfm	1/4
Rotary vane (oil-lubricated & oil-less)	0.60 to 10.0 cfm	1/15 to 3/4

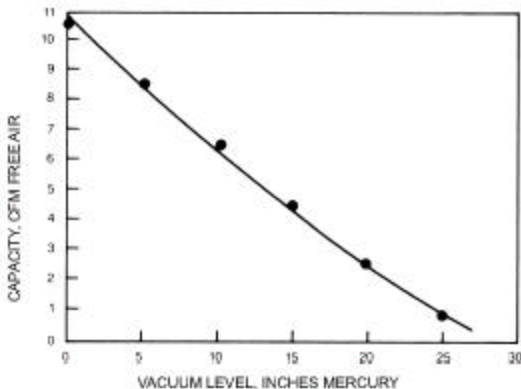

**Figure 5 Capacity versus vacuum level for a single stage reciprocating piston pump.**

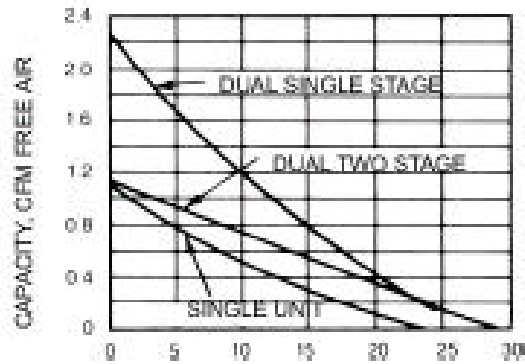

Figure 6 Capacity vs. vacuum level for different types of diaphragm vacuum pumps: single cylinder, twin cylinders in parallel (dual single-stage), and twin cylinders in series (dual two-stage).

#### 3.4.1.1 Pump Recommendations

Some recommendations and considerations for choosing a pump for wood turning are:

1. The rotary vane type pumps will produce more noise than the others
2. 1/8 to 1/3 HP rotary vane pumps can be used successfully. If cost and weight are not a factor, use the larger horsepower to have more margin to handle porous wood and leaks in the system.
3. 1/3 HP rocking piston pumps can be used successfully. These are quieter than the vane pumps.
4. An oil-less design should be chosen to ensure that oil in the exhaust air does not contaminate your work, and to eliminate the need for periodic lubrication
5. A rotary vane pump can also be used as an air compressor to blow dust off the work. A piston pump used in the same manner will stall if a relief valve is not provided. This is not a consideration if the only use is as a vacuum source.
6. Choose a convenient pump primary voltage – in the USA 110/120VAC is most common. If your lathe operates on 220VAC, then that is a viable option also.
- 7.

#### 3.4.2 Nonpositive Displacement

A Shop Vacuum is a nonpositive displacement pump, and it's a common tool in almost any wood shop.

Any good shop vacuum will draw an inch or two of vacuum. The drawbacks of this type of system are:

1. Noisy
2. Can't hold small objects because it may not provide sufficient vacuum.
3. Must ensure a flow of air to the motor (e.g. lots of leakage) to avoid overheating it i.e., in this type of vacuum pump, the air that the vacuum pump draws is the same air as is used to cool the motor. If the air is restricted, such as it would be in the situation of a vacuum chuck, the motor does not get sufficient cooling.
4. Your shop vacuum will wear out faster

The advantages are:

1. Almost free (everyone has a shop vacuum)
2. Can tolerate a system with quite a lot of leakage
3. Dust and shavings are no problem
4. Minimal special equipment

## **4 How do you hook it up?**

The key parts of a positive displacement vacuum hookup are:

1. The pump
2. A filter to keep dust and shavings out of the pump
3. A bleed valve to control vacuum
4. A vacuum gauge (optional) so you know what's happening
5. A rotary vacuum fitting on your lathe
6. The chuck itself

Non-positive displacement systems can be connected as shown in 4.2.

### **4.1 Setting Up a Positive Displacement Vacuum Pump**

Figure 7 shows a typical setup for a positive displacement pump. In this case, the lathe has a built in vacuum port, and the pump is 220 VAC. Section 4.3 shows how to make a rotary fitting if your lathe is not equipped with a built in vacuum port. The choice of 220VAC for the pump versus 110AC is a matter of convenience. If you can get a better price on a 220VAC pump and you have 220VAC handy, then by all means use it. If you don't have 220VAC, then of course you will want to limit yourself to 110VAC pumps.

When you wire the electrical portion of the setup, you will wish to decide where to place the switch. There are two basic strategies:

1. Place the switch physically near the pump, typically on the pump body itself, or
2. Place the switch at some distance from the pump.

If you will use the pump with several lathes, or for other purposes, then you will want to mount the switch on the pump. On the other hand, if this is a permanent installation, the pump is best placed in an out of the way location, and so you should mount the switch where you can reach it easily. If you are adding wiring (for example the 220VAC plug in the diagram), then it may be expedient to include a wall-mounted switch. If you mount the pump where you cannot hear if it is running or not, then include an indicator with the switch to remind you that the pump is on.

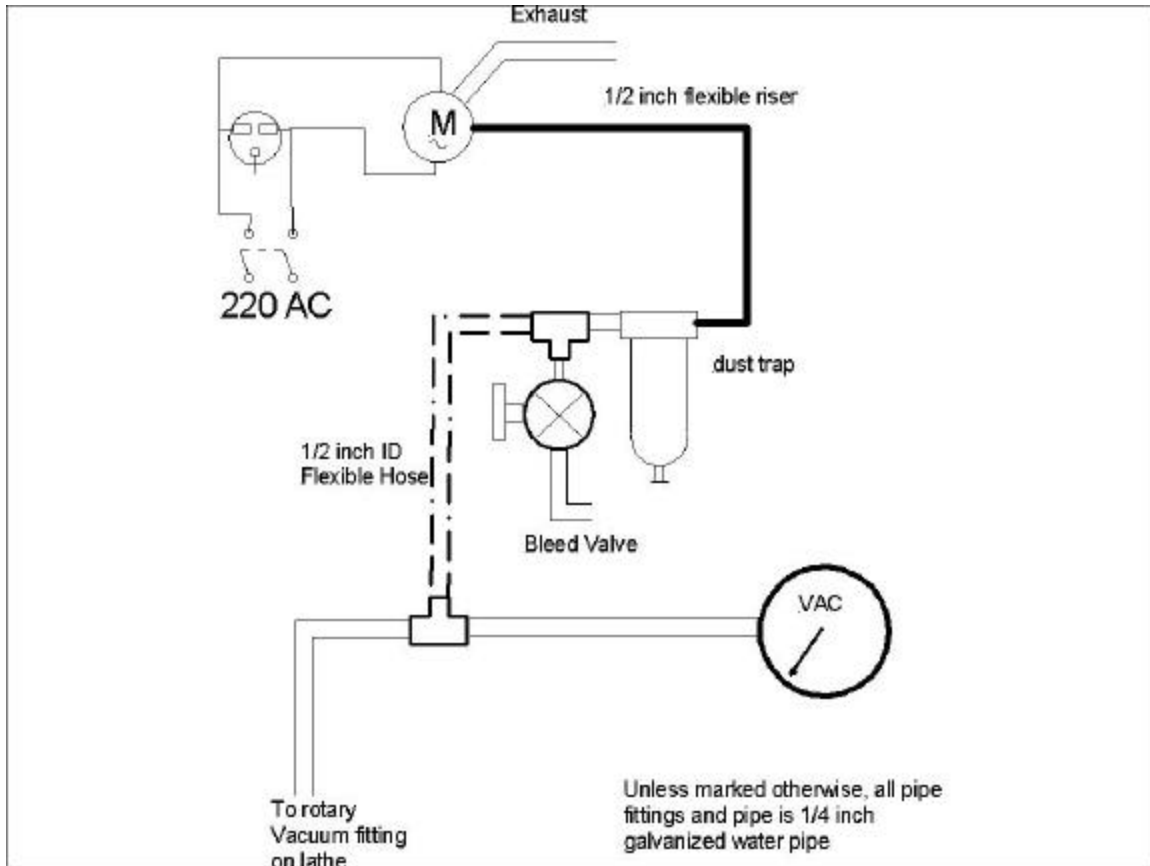

Figure 7 - A typical setup for a positive displacement vacuum pump

#### 4.1.1 Muffler

In the diagram above, the exhaust from the pump is shown going into a pipe. Depending on the type of pump, you may well wish to make some kind of muffler to quiet the sound of the pump. This is particularly true for vane type pumps, which if unmuffled sound rather like a siren at close range. I used a dual wobble piston pump, so there was significant pulsation in the output air. To make a muffler, I attached about 6 feet of scrap medical air hose – the clear flexible hose that is used with oxygen apparatus. I just coiled this hose up after connecting it to the output port. The hose I used was  $\frac{3}{4}$  ID and slipped nicely over a  $\frac{1}{4}$  to  $\frac{3}{8}$  inch adapter. The particular hose has accordion style ripples in it which break up the sound waves, so that over the 6 foot length the pulsations are pretty much damped out. I then took the output of the hose and directed it at the pump motor to provide additional cooling.

If you have a vane type pump, they usually come with an input and output filter/muffler. If you lack one, a baby food jar with some cotton wool in it will do nicely.

#### 4.1.2 Mounting the pump

All pumps vibrate, some more than others. Vane pumps vibrate the least. I initially hard mounted the pump to the ceiling plate of my workshop. This got the pump out of the way so I didn't have to worry about tripping over it, and it protected my fingers from the pump's fan blades. But, by hard mounting it, I ended up coupling all of the vibration from the pump into the wall, which acted as an amplifier. To quiet it down a bit, I added some rubber between the pump and the mounts – a few scraps of an old tire will do fine, as will pieces of a mouse pad or anything else convenient. I would not use Styrofoam because it doesn't hold up very well over time.

### 4.1.3 Filter

A filter or a series of filters is needed to keep dust out of the pump. A commercial air line filter will work well. You can make your own filter by using some large diameter galvanized pipe (for example, 2 inch) filled with cotton wool or wadded up filter medium or even a rag. Put a cap on each end and drill and tap the cap for ¼ inch pipe (or use a reducing fitting). Filters with a clear jar allow you to see what's piling up in the filter and know when to change it. If you were using a vane pump with its own filter, I'd still add another in-line filter just to be safe. The carbon blades on a vane pump are too expensive to have to replace them due to sawdust damage.

### 4.1.4 Bleed Valve

As illustrated in Table 1 at the beginning of this paper, even a modest vacuum applied to a large surface area can produce forces on the work piece. Therefore you need some way of ensuring that you don't crush the work piece. You do this with a bleed valve, which basically lets you leak air into the system in a controlled manner. You can use pretty much any valve, although I would recommend against a gate valve because they typically do not seal well. You want the valve to seal well for those times when you really do need maximum vacuum.

There are ball valves (used for gas shutoff type applications), but they are too hard to adjust for small flow rates. So the best choice is a small (for example ¼ inch) water valve that takes several turns on the handle to go from fully closed to fully open.

### 4.1.5 Hose and Pipe

Unless you have a lathe with a built in vacuum fitting AND you mount the entire mechanism to the lathe, you will want to use flexible hose to connect the portion of the system on the lathe to the portion not on the lathe. This is shown as the ½ inch flexible hose in the diagram above. I also found it expedient to not have to cut and thread a lot of pipe, so I used ½ inch flexible sprinkler pipe (called "flexible riser") to connect from the dust trap to the vacuum motor. Conveniently, the OD of ¼ inch galvanized pipe is just about ½ inch, so you don't need fancy fittings to go from the threaded fittings (which for the pumps and whatnot that we are talking about are usually ¼ inch) to the flexible hoses, just use short lengths of ¼ inch galvanized pipe.

A hose clamp at each end of each hose will minimize vacuum leaks.

### 4.1.6 Gauge

A vacuum gauge is handy so you can see what's happening, but it probably isn't essential. And, accuracy is not important, so pretty much any old gauge will do. If you are assembling a system and don't have a gauge handy (yet), then leave a place for it (as shown in the figure) and just close it off with a pipe cap or plug until you are ready to affix a gauge. If you don't do this, you may find that you have to undo a whole bunch of fittings when you decide to add a gauge later.

You can usually find gauges at surplus stores and swap meets – they are often found around car parts swap meets because they are used (or were used) to diagnose engine problems. If you find a gauge with a broken lens (glass), don't despair; you can make a new one out of plastic on the lathe. If the gauge is missing the bezel that holds it in place, use tape or silicon glue to affix a new lens. You do want to cover the gauge though rather than have no lens because otherwise it will collect dust inside and quit working.

## 4.2 A quick setup for a non-positive displacement pump

This method is courtesy of the Peninsula Woodturners Guild (K. MacLeod.) <http://home.vicnet.net.au/~pwguild/vacuum.htm> with a few additions by the author.

The discussion in this section sets forth a quick and easy way to make a shop vacuum based system.

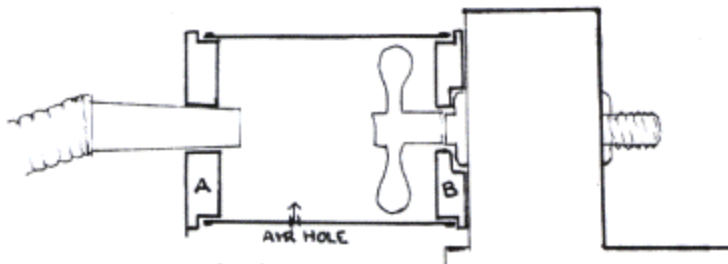

Figure 8 Simple Vacuum Connection

- 1.. Find a can with diameter just larger than that of hand wheel such as an olive oil can (a length of suitable diameter PVC pipe will also work).
2. Cut out both ends.
3. Turn A from craft board to fit snugly into can. Turn hole to fit vac. hose end. Fix can to A with nails or screws or glue or contact cement.
4. Turn B. to push fit into can. Turn hole to fit over shaft or bearing housing or whatever.
5. Fix B permanently to lathe head. Drill and tap holes for small metal thread screws, or use contact cement, or epoxy putty.

### COMMENTS

Drill a hole (say 4 mm.) somewhere along the vacuum. line to allow some airflow to cool the motor otherwise you might cook it.

If your hand wheel must be removed for any reason you can use a smaller can, but you then have the bother of removing the hand wheel each time, and you lose the advantage of the quick fit.

A slight concavity in the face of the suction pad allows for a more positive grip on flatter objects like coasters or platters.

Remember strength of suction depends on area of job (Lbs / sq. inch) so larger jobs grip very firmly. Be wary of the small diameter. jobs.

#### 4.2.1 ADJUNCT TO VACUUM CHUCK

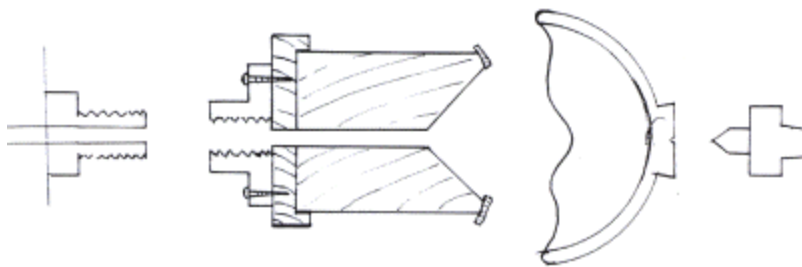

Figure 9 - A simple Vacuum Chuck

If you want to modify the foot of a natural edged bowl using a vacuum chuck try something like this.

Basically it is a large wooden tube with the rim curved to nearly match that of the inside of a bowl, and with the rim edge covered with the usual sponge rubber material to make a good suction seal. (See 4.5 for another suggestion, and note that a non-porous wood should be used, for example maple or even MDF, not oak. A couple of coats of lacquer or paint will help seal the wood so it doesn't leak)

It is necessary to leave some means of centering the bowl onto the vacuum chuck adaptor using the tail stock until the vacuum takes over, then remove tail stock and finish foot of bowl to your design.

Remember small diameter vacuum chucks do not grip as positive ly as larger ones.

#### 4.3 How to make your own rotary fitting

You can buy a commercially made rotary fitting to connect the vacuum to your lathe's spindle (see section 5), or you can buy a lathe like the Stubby that has a vacuum port built in, or you can make your own rotary fitting.

Figure 10 shows how to make such a fitting. You need some tubing that will seal to the spindle, a double sealed ball bearing, a block of wood, and a short piece of ¼ inch NPT pipe.

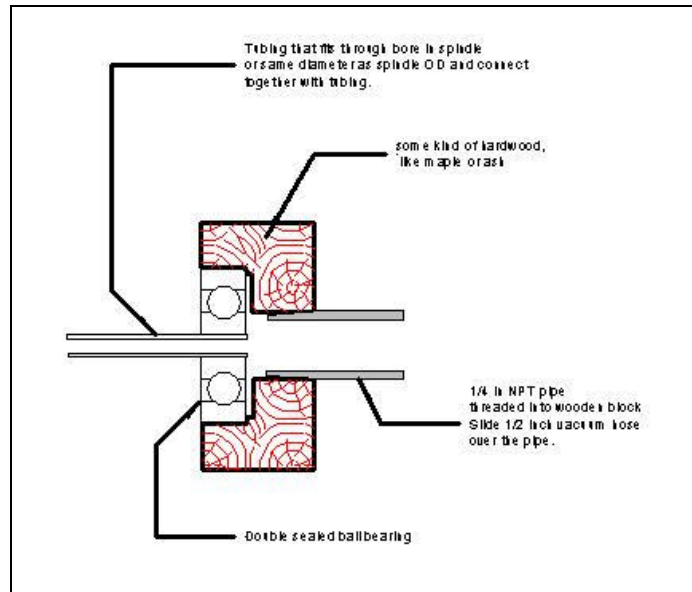

**Figure 10 - Make Your Own Rotary Vacuum Connection**

The bearing ID should match the tubing you have chosen to mate with the spindle. The bearing OD is not critical. Turn a recess in the wooden block to hold the bearing, and leave a small “shelf” that extends about 1/8 of an inch into the recess, as shown in the figure. This gives the bearing outer race something to sit against without any risk of the inner race rubbing on the wood.

Then, drill and tap a hole for the 1/4 NPT pipe in the center of the block, and thread the pipe into the block. Use RTV or polyurethane glue to seal the bearing outer race to the block. Provide some way to ensure that the block does not rotate, and you are done.

Note that it’s perfectly OK to reverse the above assembly and have the block rotate with the hand wheel if this is more convenient.

On the commercial units, the small tube slides through the hole in the spindle and is then sealed to the working end of the spindle with a special fitting. There are a number of ways of duplicating this, including having the small tube screw into the vacuum chuck itself, using RTV silicone adhesive to seal the small tube to the inside of the spindle, and using an O-ring and screws to clamp and seal the assembly to the hand wheel (this of course reverses the above assembly).

If you want a more rugged unit, two ball bearings spaced half an inch apart will add significantly to the ability of the unit to withstand lateral forces, such as caused by the weight of the vacuum hose.

If you do not have a hole through the center of your spindle, there is an adapter (see section 5.1) that will allow you to deal with this situation.

## **4.4 How to make the chucks**

### **4.4.1 A flat chuck**

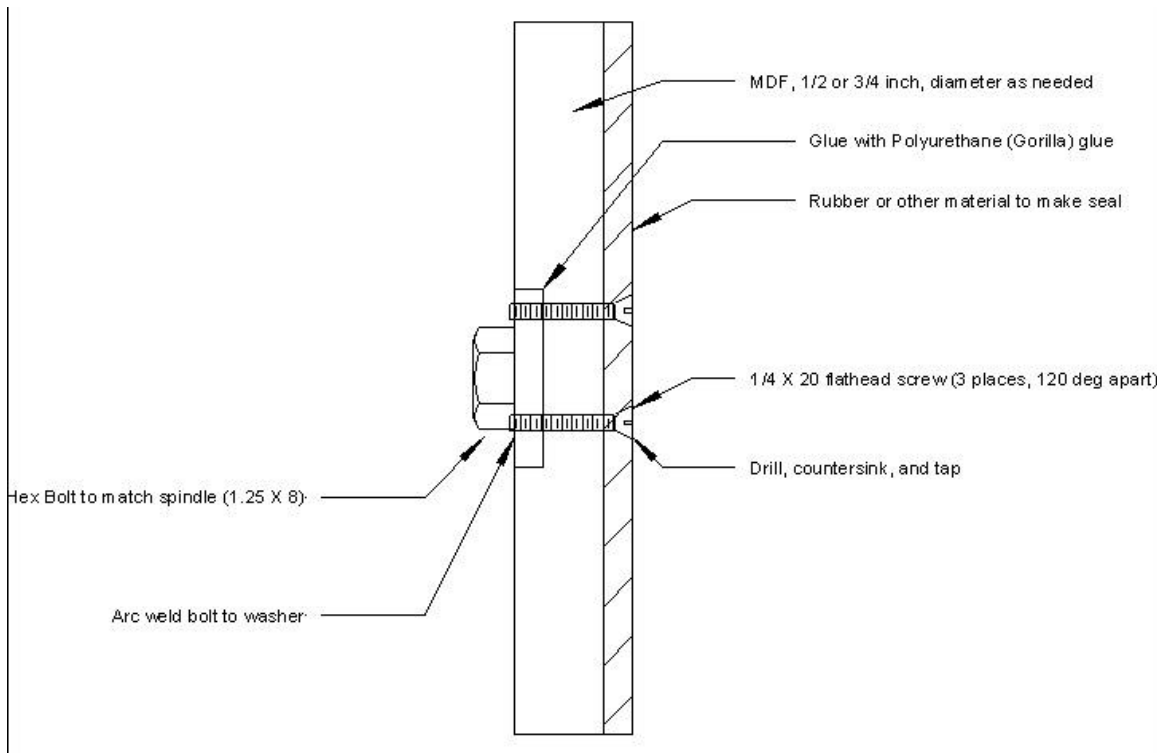

The figure above shows how to make a simple flat vacuum chuck. Purchase a nut that matches the threads on your spindle. Weld the nut to a washer (so you can space the screws out some distance away from the spindle and get more strength). Arc welding is almost mandatory here, a gas welder will heat the whole nut and may cause unacceptable distortions (and it will take forever).

A good diameter for this chuck is 12 to 18 inches, or the maximum your lathe can tolerate, which ever is smaller.

Mount a piece of  $\frac{1}{2}$  or  $\frac{3}{4}$  inch MDF or LDF on a faceplate and turn a recess about  $\frac{1}{8}$  of an inch deep whose diameter is very close to that of the OD of the washer (about  $\frac{1}{16}$  " oversize is good). You may also wish to turn it approximately round so you don't get your knuckles smacked by a sharp corner, but you will turn it round again in a later step. Glue the washer into the recess using urethane glue or epoxy or even RTV. Drill 3 (or 4) holes and tap them to accept mounting screws – I use  $\frac{1}{4}$  X 20 TPI flat head screws. You want to use flat head screws so they can be flush with the MDF surface when countersunk. If you choose to let the glue dry before drilling, then use the tail stock to apply pressure to the nut to hold it against the MDF.

It may be possible to omit the screws, but I would be loathe to do so – I would hate to discover that the glue sheared during some operation causing the MDF to separate from the washer/nut assembly. Once the screws are installed and tightened, put the assembly onto the lathe and start the lathe. Use a sharp skew to trim the MDF so it is running true – you will want to trim the edges to make it round, and you will want to cut the face so that it doesn't wobble. Use a straight edge if you like to make sure it is reasonably flat. Then use a drill, or a skew and cut a hole through the MDF in the center so the vacuum has a place to suck through. This hole is not shown in the figure.

When you are done, spray on a layer of adhesive and cover the face of the MDF with closed cell foam. An old mouse pad will work, as will router table rubber, wetsuit rubber, and so on. You now have your first vacuum chuck.

This configuration is useful for items with a flat top, such as a bowl or box.

#### **4.4.1.1 A useful variation on the flat chuck**

If you make another flat chuck like the one above, but with the disk diameter about 4 or 5 inches, you can make an internal bowl chuck. After assembling it and trimming it so it is concentric and flat, glue a piece of rubber pad that is at least one inch in radius (or two inches diameter) larger than the MDF disk onto the MDF. You will now have an MDF disk with rubber hanging off the edge.

Put this mess on the lathe after the glue is dry and bring the speed up until the rubber is held fairly flat by centrifugal force. Use a sharp parting tool to trim the rubber round leaving it extending at least an inch (but not more than 2 inches) beyond the edge of the MDF.

The extra rubber will conform nicely to the inside of a bowl or other object that is not really round, or that has a natural edge and thus cannot be held with the flat chuck.

#### **4.4.2 A raised chuck**

Construct one or more flat chucks as described above, but don't glue any rubber to them. Make one about 5 inches in diameter, another about 7. Get a short (one foot will do) length of 4 inch PVC pipe and of 6 inch PVC pipe.

Mount the 5 inch chuck you just made on the lathe and cut a very shallow groove in it with a parting tool at about 4 inches diameter. Test with the 4 inch PVC to see if it is exactly right, and adjust until it is a very close fit to the PVC. Then, cut the groove  $\frac{3}{4}$  of the way through the MDF. Press the PVC into the groove, put a piece of wood across the far end and hold it in place with the tail stock. Cut it with a cut off tool 4 to 6 inches from the MDF.

Then glue the PVC pipe into the groove using epoxy or urethane glue (not RTV). Put some glue of your choice into the slot, reverse the PVC so that the edge you just cut gets pressed into the slot, and push it in. You will want to make sure that the pipe is pretty well centered, so after pressing the PVC into the slot, rotate the lathe by hand and note the runout of the PVC.

The easiest way to do this is to move the tool rest close to the end of the pipe and rotate the lathe by hand. When the pipe the closest to the rest, move the rest so it just touches the pipe. Then turn the work 180 degrees with the handwheel. The pipe will now be at it's farthest location. Move it half way back to the tool rest and repeat the process. You can stop when the total runout is less than 1/16, in fact 1/8 is probably ok.

After the glue dries you can either build up a lip using hot melt (see Soren Berger's note on seals, below) or you can make a second MDF disk with a groove that matches the PVC and glue it on the headstock end. When the glue dries a second time, you can turn

the second MDF disk into a lip (about 3/4 inch wide) that will be concentric to the lathe axis even if the PVC pipe is not perfectly concentric.

Repeat for the 6 inch pipe. Note that you can make these as large as you see the need.

## 4.5 Seals for the chucks

### 4.5.1 Soren Berger's note on seals

Soren Berger posted the following note on rec.crafts.woodturning. The author has tried this approach, but has found that fully cooled hot-melt adhesive is too rigid for all but the most perfectly round objects. So, if there is any warping in the item, a more resilient seal would be beneficial. However, if the adhesive is allowed to cool somewhat but not totally, then it works as Soren describes.

*The best seal material for the leading edge of any vacuum chuck is hot glue. To use this just turn a groove in the front edge of your MDF or PVC chuck generously fill this with your hot glue gun, allow to cool then turn this into the required shape to fit object you wish to hold. You now have a seal which has some give, is slightly tacky and easily repaired.*

*Cheers Soren*

### 4.5.2 Other seal material

For the seal, you may wish something resilient like rubber, or you may want something pretty hard. It depends on whether the item (bowl or whatever) is really round or has a flat (planar) edge to seal to, or if it is elliptical or not flat. Table 7 identifies other materials and some thoughts about them.

**Table 7 - Seal Materials**

Material	Comment
Artificial chamois (for washing cars)	Good seal to a flat/round surface. Will provide a solid base for work
Closed cell foam (mouse pad, wet suit)	More conformal, will seal to more irregular or imperfect work. But because it is flexible, the work itself can move a bit, so you will have to use much lighter cuts
Neoprene rubber	Like the chamois, it is a rigid material that won't conform much to irregular surfaces
Other foam	Make sure the foam is closed cell. An open cell foam will allow air to pass and you will have a major vacuum leak.
Styrofoam	Haven't tried it, but it's pretty brittle.

Leather	See Chamois
Vinyl	Not a good choice, too rigid to seal to any but the most perfect surface.

You can get "O" ring type belts for vacuum sweepers at the super market for about \$1.98 for 2 that are approx. 4 inch in diameter and fit nicely on the end of a piece of PVC to become a vacuum chuck.

## 5 Additional information and sources

This section contains a selection of sources and additional information. The author makes no recommendation regarding any particular source.

### 5.1 The VacuuMaster Chuck

Jennifer Shirley recently posted at the Badger Pond forum a review of the VacuuMaster vacuum adapter system <http://www.sierramold.com/Wvchuck.htm>. This is the one that Bill Grumbine was involved with and works on lathes whether or not they have a through spindle. Though the VacuuMast has been discussed here before, I thought Jennifer provided a good review and asked for her permission to post it here on the NG.

Lyn

0500	VacuuMaster Vacuum Chuck Assembly	\$289.00
------	-----------------------------------	----------



Sierra Mold encourages your questions, comments, suggestions and feedback about our products

**Call Us:**  
**775 882-3500**  
**Fax Us:**  
**775 882-2502**

**Write Us:**  
**Sierra Mold**  
**1558 Forrest Way**  
**Carson City,**  
**Nevada 89706 -0311**  
**USA**

**E-mail Us:**  
[info@sierramold.com](mailto:info@sierramold.com)

The following is a review of this product from the web:

*Date: Saturday, 2/2/02, at 3:03 a.m.*

*Hello All,*

*Recently I had the privilege to "test drive" a new vacuum chuck that's now on the market. It's called the VacuuMaster and it's made by Sierra Mold Corp. out of Carson City, Nevada. I thought I'd do a little review to let you all know my opinions on this chuck and it's performance. Let me first say that this chuck is suitable for both solid headstocks and hollow headstocks. I'm not sure if that's the correct terminology, but*

*it's all I can think of at the moment. If you use a knockout bar to remove a spur drive it's hollow. if you don't it's solid : )*

*For anyone who is not familiar with what a vacuum chuck is used for, it's main purpose is for reverse chucking of bowls or platters after they are hollowed out. Most turners like to finish off the bottom of their bowl so as not to show signs that a mechanical chuck was used. An example would be a tennon or foot with scarring from the jaws of a chuck or a recess from jaws that were expanded inside them. I'll be the first to admit that I have many bowls sitting on my shelves with recesses in them, but as I learned that I could make them look better by easing the recess or by finishing or completely removing the foot, I've since struggled with the various options to reverse chucking. Some of the options I've tried are Cole jaws which have their limitations, a compression chuck that is very difficult to re-center the work piece, a jamb chuck etc. I know one turner who cuts a groove in a 2x disc and then duct tapes the bowl to it. Whatever works? Granted, almost every form of reverse chucking has its limitations, even the vacuum chuck...but once you try one you'll be hooked. Let me just say.. it's just one more aspect of the turning addiction!*

*Right out of the packaging I could tell the VacuuMaster was made with the utmost of scrutiny. I don't know a lot about machine work but I know enough to be able to tell if the manufacturer cares about quality control. The chuck was beautifully machined and finished, looked great and was substantial in weight. It just "felt" good. The package that I received from Sierra Mold consisted of the chuck body, an adapter to fit my General 26020 lathe, two different size bells. a 3.5" and a 5"(the bells are what sit inside the bowl. Different sizes for different size bowls) a stop rod to drop between the ways to allow forward and reverse turning of the piece, a 1/4hp Gast vacuum pump with all of the necessary gauges, fittings and tubing and a full set of instructions for operation of the pump and the chuck.*

*The first bowl I used the VacuuMaster on was a walnut bowl approximately 10" in diameter and about 5" deep. After turning the pump on I put the bowl on the bell and brought the tailstock up to help me find center. After a couple of quick adjustments I turned the pump up full and pulled the tailstock away. Wow! I was amazed that the bowl just stuck there like magic! I pulled hard on the rim of the bowl and it would not budge. So away I went on the tennon that was left for the Stronghold chuck to hold onto. It seemed strange not to have some sort of apparatus in my way and obstructing my workspace. It was wonderful! I could run the lathe at higher speeds than I normally do when I use my home made compression chuck or a jamb chuck giving me cleaner cuts and a much nicer finish on the bottom.*

*The VacuuMaster ran smooth and quiet and appeared to have no run out what so ever. The bells that came with my test kit were the 3.5" and the 5". Sierra Mold offers two other sizes 8" & 10", but I have a feeling the two smaller sizes would cover most of the applications the average turner would face. One of my main concerns was the depth at which the bells could reach inside the bowls. The depth of the bells was approximately 2.5", which was fine for most of the bowls I used them on, however if you had a deep bowl to reverse it might interfere with the tubing from the chuck body. When I voiced my concerns regarding this matter to the powers that be at Sierra Mold I found out that some deeper bells are in the works right now : )*

*In conclusion I have to say that the VacuuMaster is a wonderful piece of equipment that would be a great addition to any turner's accessories stash : ) If you'd like to read and see more about the VacuuMaster just put your pointer here and click!*

*A huge thanks to Sierra Mold for allowing me to take the VacuuMaster for a "spin"!*

*(traditional disclaimers go here)*

*Jennifer*

*2/2/02*

## **5.2 Complete Vacuum Chuck kits and Rotary Fittings**

## 5.2.1 The Woodturners Catalog

(Craft Supplies USA), 1-800-551-8876, [www.woodturnerscatalog.com](http://www.woodturnerscatalog.com) has a kit called the Artisan Vacuum Chuck System. They sell the system without a vacuum pump for \$125 in the 2001/2002 catalog. This includes 2, 4, and 6 inch vacuum rings with a foam seal, a base disk, and a rotary adaptor that includes a threaded rod to fit through the headstock spindle, a rotary vacuum fitting and a #2 MT vacuum fitting for the spindle. A Gast 1/3 HP vane pump is sold separately.

## 5.2.2 Oneway



The rotary adaptor threads onto the outboard spindle of the lathe and provides a place to attach the vacuum hose. Using double ball bearings, the Rotary Adaptor keeps the hose from twisting with the rotation of the lathe. The vacuum is pulled through the hole in the headstock spindle (your lathe must have a hollow spindle with no cross holes). Your lathe must have an outboard spindle thread for the Rotary Adaptor to thread onto. Since the Rotary Adaptor uses the same insert as the Stronghold chuck, an insert must be purchased separately to use with the Rotary Adaptor.<sup>4</sup>



## 5.2.3 E-Z Vacuum Adapter

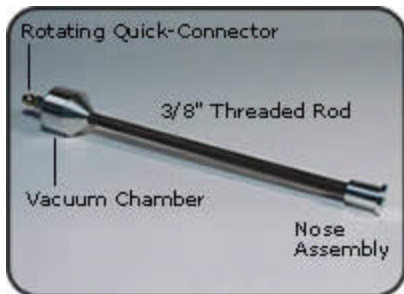

This Vacuum Adapter provides a conduit to pull the vacuum through the headstock spindle. It was designed by a professional woodturner to fit onto any lathe that has a #2 Morse Taper and a hollow headstock spindle with a 3/8" diameter hole or larger running through it. The vacuum adaptor provides a conduit for the air to go through the spindle to a user made fixture mounted on a faceplate.



The self-contained Vacuum Chamber has a quick-connector (fits standard air fittings) pressed into a sealed ball bearing that compensates for the revolving spindle of the lathe. This unit centers in the hole at the back end of the lathe spindle.

The Nose Assembly has vacuum holes and an adjustable or removable center point. It fits loosely into the Morse Taper of your lathe and beds out against the work end of the lathe

<sup>4</sup> <http://www.packardwoodworks.com/> 1-800 683-8876 Packard Woodworks, PO Box 718 Tryon, NC 28782.

spindle.

An 18" long threaded tube carries the air through the spindle while connecting the vacuum chamber and the nose assembly. They are held against each end of the lathe spindle. The workpiece is held in a user made fixture held on a faceplate or using the Drum Chucks we offer on this page.

The vacuum can be supplied by either a vacuum pump (not a shop vac) or a Venturi vacuum system that works with your air compressor.

#### 5.2.4 Pisco Rotary Joints

The following is from a company press release. The author has not examined this product.

Pisco's standard Rotary Joint incorporates a single bearing for fast swiveling connections, and is ideal for air and vacuum applications. The standard joint includes a service pressure range of 0~150psi, a negative pressure range of -29.5in.Hg, and is available in 5/32", 1/4", 5/16", 3/8" or 1/2" O.D. with a maximum Rpm of 500.

Pisco's High Rotary Joint employs two bearings, and is suitable for high-speed swiveling and swinging connections not covered by the standard model. The High Rotary Joint is also used in air and vacuum applications. The High Rotary Joint has a service pressure range of 0~150psi, and a negative pressure range of -29.5in.Hg, and is available in the following tube sizes: 5/32", 1/4", 5/16", 3/8", or 1/2" O.D. with a maximum of 1500 Rpm's.

For more information on Pisco's Quick-Fitting Rotary Joints, or any other products from Pisco contact them at Pisco U.S.A., Inc., 2228 Landmeier Rd., Elk Grove Village, IL 60007, Phone: (847) 427-1314, Fax: (847) 427-1317.

### 5.3 Thomas pumps

<http://www.thomaspumps.com>

Thomas Industries Inc.  
1419 Illinois Avenue  
P.O. Box 29  
Sheboygan, WI 53082-0029  
Tel: 920-457-4891  
e-mail: [rtaylor@thomasind.com](mailto:rtaylor@thomasind.com)

### 5.4 GAST pumps

Gast Manufacturing Inc., a Div. of IDEX Corp.  
P.O. Box 97  
Benton Harbor, MI 49023  
Tel: 616/926-6171  
Fax: 616/925-8288



A UNIT OF IDEX CORPORATION



Web: <http://www.gastmfg.com>  
E-mail: [marketing@gastmfg.com](mailto:marketing@gastmfg.com)

## **5.5 Building a Longworth Chuck**

### **The Longworth Chuck**

by Larry Pope

*[This material is from Woodturning Magazine No. 3, Spring 1991. It is published here for woodturners around the world to share by permission of the publishers:*

*WOODTURNING, GMC Publications, 165 High Street, Lewes, East Sussex, BN7 1XU ENGLAND. Telephone 01273 488005. Facsimile 01273 478606. We thank them for sharing.]*

#### **5.5.1 Introduction**

I am a member of the Northshore Woodturners Guild in New Zealand. Like many others, we exchange our newsletter with other clubs, including some in Australia. They in turn send us copies of their newsletters to our mutual benefit.

I don't remember the date, but I think it was early in 1989, that a copy of a bulletin from the Hunter Valley Club in New South Wales, Australia, was brought to my attention by our Club Editor, Nelson Rundle. It contained part one of a two part article by a Mr. Longworth on a self centring chuck which held the rims of bowls, enabling the turner to complete work on the base of the bowl. Quite a useful tool for removing all evidence of how a bowl was originally chucked when leaving bowls with screw holes, chuck recesses, etc. in the bottom is no longer acceptable.

Unfortunately Mr. Longworth died shortly after the first article and the second part was never completed, The first article contained a rather rough drawing and I was asked if I could possibly draw up something more precise I decided to go further than that and to actually make the chuck. After one or two experiments with compasses and protractor, I eventually produced a three jaw model which created a lot of interest among our members, and several more chucks were made from the plans I had produced.

Interest was also shown by visitors to our club who went away, made a few modifications and, as I see from our National Quarterly Magazine, have almost claimed it as their own. The inspiration however was that of Mr. Longworth of Hunter Valley and to him should go all the praise. It is interesting to note that Mr. Longworth's own club wrote to us to obtain plans of the chuck which we had made available to our members. I have no doubt that eventually it will be produced commercially, probably in metal with a multitude of jaws. However make one yourself, it's not difficult.

You will need

- a. A wood lathe.
- b. A router with a swing arm so that you can cut out an arc of a circle. Most routers have a little jig which attaches and allows this facility.

- c. An electric drill
- d. A screwdriver

### 5.5.2 Building Material

- A. A small face plate (not more than 100mm [4"]). Use a larger face plate if you wish but the jaws can come no closer than the width of the face plate. So the smaller the face plate the smaller the bowl which can be worked,
- B. A small wooden block 30mm [1-1/8"] thick and the same length and breadth as the face plate
- C. Piece of (6mm [1-1/4"]) good quality plywood,
- D. Piece of (20mm [3/4"] thick) close density particle board, plywood or wood board The size of the latter will depend on the maximum size of the bowls to be used. If the chuck is to be operated in board of the lathe its dimension will be limited to the maximum throw of the lathe. Otherwise, obviously, it will not fit on the lathe.
- E. Four gutter bolts with wing nuts 6mm [1/4"] diameter. Note that you will need the same diameter router bit for cutting the slots. The length of the screws will be the sum the thickness of the plywood plus the thickness of the particle board, plus the thickness of the rubber jaws, plus about another 20mm [3/4"].
- F. Rubber jaws. I use doorstops. Sink plugs are another good alternative. Any rubber shape with a hole through it.

### 5.5.3 Construction

1. Screw the wooden block B firmly to face plate and mount face plate on the lathe. Remove surplus wood until you have a disc the same size as the face plate. Check that the face of this disc is true. If it isn't, clean it up.
2. Take the piece of plywood C and the piece of particle board D and cut each into a circle. The diameter should be close to the maximum size you require the chuck to be. This doesn't have to be precise as you will true it up later on the lathe. The best method of cutting the wood is by using a bandsaw, a jig saw, a coping saw, a fret saw or any saw in that order.
3. Glue and screw the face plate and wood block to the centre of the particle board disk. Get it as accurate as possible but don't get neurotic about it.
4. Place the face plate in a vice, or between two pieces of timber, with the particle board uppermost. Now tack the piece of plywood to the particle board. Avoid tacking through the centre of the piece. Use sufficient tacks to make it secure, Don't use too long a tack as they will have to be removed later. Make sure that the heads of the tacks do not protrude or else later on they will impede the movement of the router.
5. Mount the chuck on the lathe and clean up the edges so that we have two precise disks. Using a pencil, and with the lathe rotating at slow speed, accurately locate the centre of the disk. It Is very Important that you locate the exact centre, so take your time over this. Now remove the chuck and mount in the vice, or across two pieces of timber, as previously. Make sure it is in a stable and comfortable position for you to work on.
6. From here on it all gets a bit nerve wracking. We are going to make a 4 jaw chuck, It

would be better if it were a 6 or more jaw chuck. The more jaws the more firmly it will grip. However a 4 jaw works well enough and is more simple to describe. One day I will make one in metal and make it a 10 jaw.

Through the centre draw two diameters each at right angles to the other. Now draw three circles around the centre:

1. One the same diameter as the face plate.
2. One 21 mm [13/16"] in from the outer edge,
3. One midway between the two circles just drawn.

If you don't have a compass large enough then just mark along one of the diameters the radii required, Then remount the chuck in the lathe and, resting a pencil on the tool rest at each marked spot. rotate the lathe at a very slow speed and describe the circles. Then remove the chuck and set up as before.

7. At the intersection of the mid circle with each diameter, a small indentation should be made. There are four of them (C1, C2, C3 and C4 as shown in Figure 1). These points should be very accurately marked as they are the centres about which the router will rotate. So take a lot of care here.

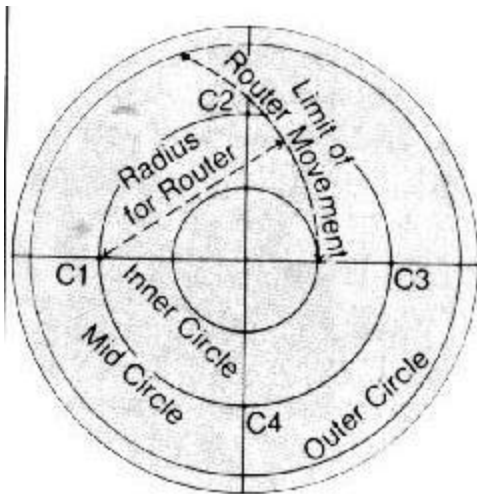

**Figure 1. Showing Router Movement.**

8. Now prepare the router for use. The router bit needs to be the same diameter as the gutter bolts. It will need to be deep enough to cut through both the plywood and the particle board. Set it up so it will swing about a centre. The radius of the swing is from the centre just calculated to a position just past the other side of the inner circle. The slot so made should not enter the inner circle but just graze the edge, Set the radius carefully because once you have started, you may not change it or allow it to change. Figure 2 shows the direction of cut for a chuck which is to be used inboard of the lathe. Reverse the direction if it is to be mounted outboard. (Anti-clockwise instead of clockwise.)

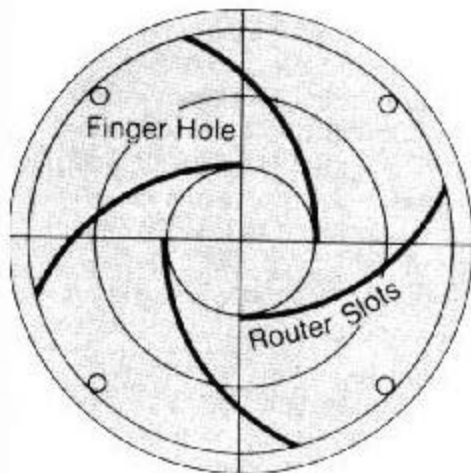

**Figure 2. Showing Router Slots.**

Now begin cutting the slots. They begin at the outer circle and finish when the router reaches the opposite side of the inner circle. Make sure you do not exceed these positions. Make sure also that the point of radius of the router is correctly located. Increase the depth of each cut slowly. Take much time and care over this stage of the chuck's construction. Its ultimate accuracy will depend on how well you do this routing. Continue cutting each slot until eventually you come through the other side.

9. When the routing is completed, you must cut several finger holes. The purpose of these is to assist in the rotation of the chuck disks when positioning the bowl to be worked. Make four holes, about 15mm [5/8"] across, near the edges in an area well away from the slots. Lastly, drill a hole through the centre of the plywood disk through the particle board and into the wood block. Ultimately the plywood disk will be located on the particle board disk by a screw. The first drilling should be deep enough to take the length of the screw and no wider than is necessary to allow the screw to bite into it. Now use a drill bit the exact diameter as that of the screw. It is essential to have a snug fit. Drill only through the plywood disk.

10. Now remove the tacks holding the plywood disk. Rotate the plywood disk. If you have cut accurately, each set of slots will line up exactly with the next set. Lightly sandpaper the slots and ensure that the gutter bolts will move easily within them.

11. Lightly grease the surface of the particle board and place the plywood disk back onto the particle board but in reverse order to what it was before.

The upper surface is now against the particle board and its other side is now uppermost. Screw the plywood disk to the particle board disk through the centre until the screw is fully home but still allows the upper disk to move freely. Now assemble the jaws as shown in Figure 3, with the wing nuts to rear. The chuck is now completed.

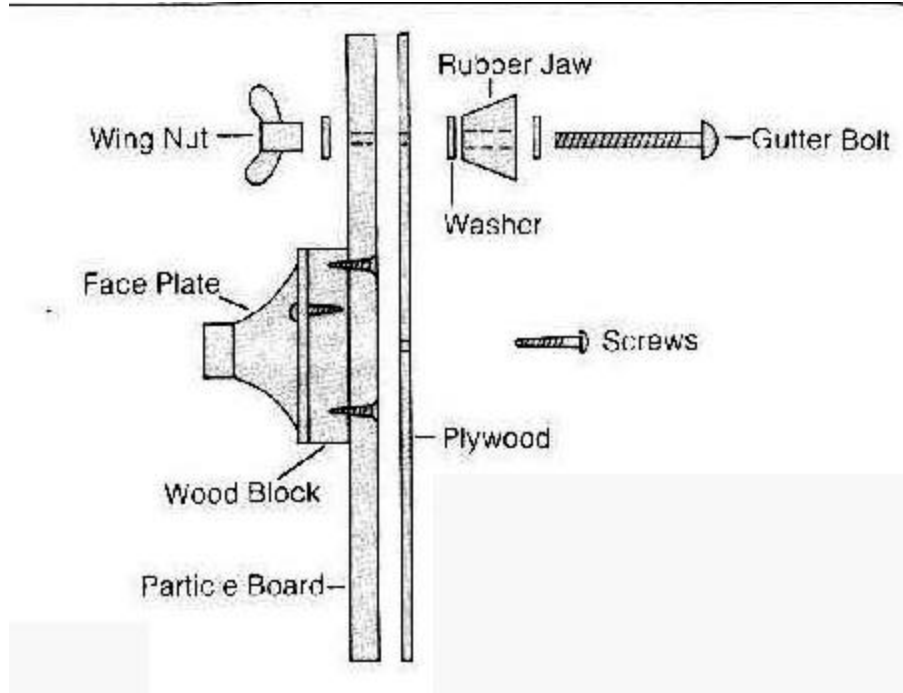

**Figure 3. Shows the assembly of the chuck.**

12. Place the chuck back on the lathe and, with the gear ratio at its lowest speed, start up the lathe. If the wing nuts have not been tightened, the jaws will move towards the centre ... a safety factor which will ensure the chuck will always have some degree of grip on your bowl. Note that the previously, oh so obvious jaws have now become a blur. I guarantee that, the first time you use the chuck, you will get a smack across a finger from one of them. For this reason always run the machine at slow speed. A bruised finger is better than a broken one.

13. Now get one of your most least liked bowls to try it out. If the edge of the bowl turns out, apply the jaws to the outer edge of the bowl. If the outer edge of the bowl turns inwards, apply the jaws to the inside of the bowl edge (Oh bliss, no bruised fingers). Place the chuck on a bench and lay the bowl on it. Bring the jaws to the edge of the bowl using the finger holes, and begin to tighten the wing nuts, a little at a time, until the bowl is firmly gripped. Now place the chuck back onto the lathe and bring the tail stock up as a safety measure. Position the tool rest and start the machine. It should run true.

#### Indispensable

Until you get used to the chuck, use a light scraper for your initial work and keep the tail stock in position for as long as possible. Having given it a light scraping, try a gouge and see how it goes. Don't make deep cuts. you don't want to risk a dig in and the whole thing coming off the chuck, I have ruined two masterpieces on this chuck, so always have a healthy respect for it. When you have got the hang of it you will find it indispensable. Happy turning!